

(12) INTERNATIONAL APPLICATION PUBLISHED UNDER THE PATENT COOPERATION TREATY (PCT)

(19) World Intellectual Property Organization
International Bureau



(43) International Publication Date
25 May 2001 (25.05.2001)

PCT

(10) International Publication Number
WO 01/37123 A2

(51) International Patent Classification?: G06F 17/00

(21) International Application Number: PCT/US00/31585

(22) International Filing Date:
15 November 2000 (15.11.2000)

(25) Filing Language: English

(26) Publication Language: English

(30) Priority Data:
09/440,212 15 November 1999 (15.11.1999) US
09/516,687 1 March 2000 (01.03.2000) US

(71) Applicant (for all designated States except US): SUPER-SIG.COM, INC. [US/US]; 219 Rose Avenue, Venice, CA 90291 (US).

(72) Inventors; and

(75) Inventors/Applicants (for US only): JEFFREY, Mark,

D. [US/US]; 821 9th Street, #5, Santa Monica, CA 90405 (US). BURGESS, Matthew, T. [US/US]; 30 Clubhouse Avenue, Venice, CA 90291 (US). DIEKHOFF, Martin [US/US]; 111-1/2 Screenland Drive, Burbank, CA 91505 (US).

(74) Agent: CAVANAGH, Daniel, M.; Christie, Parker & Hale, LLP, Post Office Box 7068, Pasadena, CA 91109-7068 (US).

(81) Designated States (national): AE, AG, AL, AM, AT, AU, AZ, BA, BB, BG, BR, BY, BZ, CA, CH, CN, CR, CU, CZ, DE, DK, DM, DZ, EE, ES, FI, GB, GD, GE, GH, GM, HR, HU, ID, IL, IN, IS, JP, KE, KG, KP, KR, KZ, LC, LK, LR, LS, LT, LU, LV, MA, MD, MG, MK, MN, MW, MX, MZ, NO, NZ, PL, PT, RO, RU, SD, SE, SG, SI, SK, SL, TJ, TM, TR, TT, TZ, UA, UG, US, UZ, VN, YU, ZA, ZW.

(84) Designated States (regional): ARIPO patent (GH, GM, KE, LS, MW, MZ, SD, SL, SZ, TZ, UG, ZW), Eurasian

[Continued on next page]

(54) Title: E-MAIL LINKING AND DISPLAY SYSTEM



WO 01/37123 A2

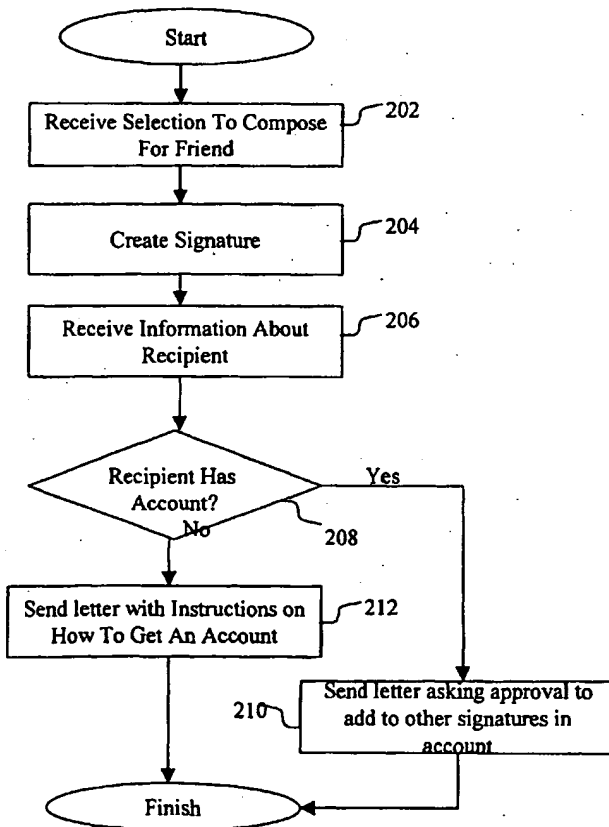

(57) Abstract: An electronic mail (e-mail) system to deliver dynamic and multi-source e-mail content over the Internet. Content for portions of an e-mail message are composed incorporating dynamic and multi-source e-mail elements using a composition application accessible via the Internet. The composition application translates the e-mail portion compositions into e-mail content generation instructions that are stored in a location accessible to an e-mail content server. E-mail content tags are created that adapt an e-mail client to request e-mail content from the e-mail content server via the Internet. The e-mail content tag is inserted into an e-mail message to be sent to the e-mail client. The e-mail client uses the e-mail content tag to request an e-mail content from the e-mail content server. The e-mail content server generates the e-mail content based on the e-mail content generation instructions and sends the e-mail content to the requesting e-mail client for display within the body of the e-mail message.

BEST AVAILABLE COPY



patent (AM, AZ, BY, KG, KZ, MD, RU, TJ, TM), European patent (AT, BE, CH, CY, DE, DK, ES, FI, FR, GB, GR, IE, IT, LU, MC, NL, PT, SE, TR), OAPI patent (BF, BJ, CF, CG, CI, CM, GA, GN, GW, ML, MR, NE, SN, TD, TG).

For two-letter codes and other abbreviations, refer to the "Guidance Notes on Codes and Abbreviations" appearing at the beginning of each regular issue of the PCT Gazette.

Published:

- *Without international search report and to be republished upon receipt of that report.*

E-MAIL LINKING AND DISPLAY SYSTEM

BACKGROUND OF THE INVENTION

This invention relates generally to electronic mail (e-mail) messages, and more particularly to a method and system for content generation for a portion of an e-mail.

The use of electronic mail has become a popular way to communicate. Indeed, many individuals have e-mail accounts, whether at work, at home, or both. The e-mail accounts are used to send and receive e-mail messages from friends, business associates, family, and others. A sender uses an e-mail composition program such as Netscape, Eudora or Microsoft Outlook, or an on-line composer such as Yahoo, to compose a message to another person. The sender is connected to a server that is connected to the Internet. The sender addresses the message to another party by specifying a location to send the message to. Usually this location consists of a server connected to the Internet. An e-mail reader accesses the server, retrieves the message and views the content using an e-mail program such as Netscape, Eudora or Microsoft Outlook, or an on-line viewer such as Yahoo.

The e-mail message may include content comprising text, graphics, sounds, video and advertisements, as well as selectable text that, for a reader with a suitably equipped e-mail reader and web browser, will request data from a website. The content of the e-mail message is stored digitally. The content is often included in an e-mail through the use of hypertext markup language commonly known as HTML.

Often an HTML page includes tags that instruct the viewing software how to format elements on the page, and how to acquire the non-text elements of the page. The tags are usually transparent to the reader, who only sees the result of the tags. This is analogous to tags in a word processing program that has tags not normally visible to the reader telling the program, for example, to underline, bold, or italicize a word or a sentence.

In a world where a person is bombarded with many different types of e-mail that is often written for the most part in very similar, static text, there is often a desire to personalize a message. Personalization or differentiation by way of special stamps, stickers, envelopes or letterhead of traditional mail is not available when using e-mail. Some e-mail senders may prefer that their e-mails contain something special for the reader, such as something thought provoking, or funny, that the reader may appreciate. Both people and businesses find it desirable to impart a consistency to their electronic correspondence to further their image. This personalization has found one outlet in the signature area of an e-mail.

As part of an e-mail, a user is able to send a symbolic signature. The signature area of an e-mail usually consists of a closing salutation and a name. Over time people have tried to personalize their signature area to convey a personalized message at the bottom of their e-mail. For example, someone might have a phrase, rhyme or poem that they send at the bottom of all of their e-mail messages. Others have attempted to craft creative designs out of ordinary (ASCII)

1 text characters.

5 Several popular e-mail programs allow a user to customize their signature area to automatically include a given piece of text or other static element as part of a "signature" on all of their e-mail. These programs usually limit the types of information that can automatically be placed into a user's signature area. In addition, in order to change the signature a user has to manually add every new element. Thus, if someone wants to have a new poem in their signature every day, then every day they have to sit down and type it in. Furthermore, the ability to maintain an automatic signature varies greatly depending on the e-mail software utilized.

10 Generally, the content of the signature has been stored on a user's computer or in a user's account along with their online composer. Generally signatures are generated at the time the e-mail is sent and are not changed when read by a receiver. Accordingly, unique customization of signature areas of e-mails poses difficulties.

SUMMARY OF THE INVENTION

15 Instructions for generating a portion of an e-mail message are created and stored on a e-mail portion server accessible via the Internet. An e-mail content tag is created for use by an e-mail client to request an e-mail portion generated according to the e-mail portion generating instructions. The e-mail content tag is provided so that the e-mail content tag can be included in an e-mail message. Upon receiving a request for an e-mail portion, the e-mail portion server generates an e-mail portion according to the e-mail portion generating instructions. The e-mail portion server sends the generated e-mail portion in response to the e-mail portion request.

20 In an alternative embodiment, the contents of the e-mail portion are generated according to a recipient profile. The recipient profile is based on the address of the recipient. Alternatively, the recipient profile is based on the system capabilities of the recipient host.

25 In an alternative embodiment, the contents for the e-mail portion may come from another server accessible via the Internet such as a presence-server.

30 In another alternative embodiment, the e-mail portion contains a link to another application. The link enables an e-mail client to invoke another application and send the application an argument. Exemplary invoked applications include Internet clients in communication via the Internet with an application server, chat applications, and Voice Over Internet Protocol (VoIP) applications.

35 In another embodiment, an e-mail server is used to insert e-mail content tags into outgoing e-mail messages. Alternatively, an e-mail content tag is selected based on the recipient address.

BRIEF DESCRIPTION OF THE DRAWINGS

These and other features, aspects, and advantages of the present invention will become better understood with regard to the following description, appended claims, and accompanying

1 drawings where:

FIG. 1 is a use case diagram for an exemplary enhanced e-mail system that delivers dynamic and multi-source e-mail content;

FIG. 2 illustrates a signature in accordance with the present invention;

5 FIG. 3 is an object diagram of exemplary software objects that may be used to implement the use of static elements within a signature;

FIG. 4 is an exemplary deployment diagram for the software objects depicted in FIG. 3;

FIG. 5 is a diagram of an exemplary architecture for a general purpose computer capable of serving as a host;

10 FIG. 6 is a sequence diagram depicting the main sequence of communication between the exemplary software objects of FIG. 3;

FIG. 7 is a flow diagram of a process of static element composition according to the present invention;

FIG. 8 is a flow diagram of a process of composing a cohesive group-wide signature;

15 FIG. 9 is a sequence diagram illustrating the communication sequence between software objects implementing a dynamic element within a signature;

FIG. 10 illustrates an embodiment of the use of a presence server to provide content for a dynamic element.

20 FIG. 11 is a flow diagram of a process of dynamic element composition of the present invention;

FIG. 12 is a flow diagram of a process of composition of a dynamic third party element of the present invention;

FIG. 13 is a cooperation diagram illustrating the use a signature to invoke an application outside of a recipient e-mail client;

25 FIG. 14 is a sequence diagram of an exemplary communication sequence when a signature is used to invoke another application;

FIG. 15 is a sequence diagram of an exemplary communication sequence when a signature is used to invoke a client to communicate with an application server;

30 FIG. 16 is a flow diagram of a process of generation of an advertisement of the present invention;

FIG. 17 is a sequence diagram of a another exemplary use of an application link;

FIG. 18 is a flow diagram of a process of automatic update of local signature information;

FIG. 19 is a flow diagram of a process of a signature generation process of the present invention;

35 FIG. 20 is a block diagram of a signature server of the present invention;

FIG. 21 is a communications sequence within an embodiment of a signature server that generates signatures based on recipient profiles;

FIG. 22 is a communications sequence within an alternative embodiment of signature

1 server that places signature tags within an outgoing e-mail message based on recipient profiles;
and

FIG. 23 is a HTML fragment containing formatting tags and data;

5 FIG. 24 illustrates how a parsing function works within a dynamic content generator to
parse information from a HTML fragment;

FIG. 25 is a flowchart of a process by which a dynamic content generator uses a presence
server to create content for a signature portion of an e-mail message;

FIG. 26 is a flow diagram of the process of signature content creation and
communication;

10 FIG. 27 is a flow diagram of a process of account creation;

FIG. 28 illustrates a signature including borders;

FIG. 29 is a flow diagram of a process of border creation;

FIG. 30 is a flow diagram of a process of rendering a border;

FIG. 31 is a flow diagram of a process for creating a signature; and

15 FIG. 32 is a flow diagram of a process of compositing a signature for use by another user.

DETAILED DESCRIPTION OF THE INVENTION

FIG. 1 is a use case diagram for an e-mail system that delivers dynamic and multi-source
e-mail content. This dynamic and multi-source e-mail content is largely discussed with respect
20 to a signature portion of an e-mail message herein, although in various embodiments the dynamic
and multi-source e-mail content is for other portions of an e-mail message. With the e-mail
system of FIG. 1, e-mail sender 1010 uses the services of e-mail system 1020 to send e-mail
messages to e-mail recipient 1000. Services supplied by the e-mail system include composing
and sending e-mail messages 1015 by the e-mail sender, routing e-mail messages to the e-mail
25 recipient, and retrieving e-mail 1025 by the e-mail recipient. Signature services 1030 provides
signature services include composition of signatures 1045 by the e-mail sender and retrieval of
signatures 1060 by the e-mail recipient. In one embodiment, the signature services are extended
1055 by third party services 1040 such as providing dynamic signature content. In another
embodiment, the signature services are extended 1080 by communications services 1075. The
30 e-mail recipient and the e-mail sender use the communications services to establish a two-way,
real-time communications link with each other. The e-mail recipient uses 1085 the
communications services to communicate with the e-mail sender and the e-mail sender uses 1070
the communications services to communicate with the e-mail sender.

An overview of a signature server process in accordance with one embodiment of the
35 present invention is shown in FIG. 26. In the process of FIG. 26, the signature server creates an
account for signature generation, creates a content format for a signature, and transmits e-mail
signature content to another party. More particularly, in Block 21 the signature server creates a
e-mail sender account. The signature server creates the e-mail sender account by presenting to

1 a e-mail sender, using a user computer, a series of menus viewable using a web browser. Using
the menus provided by the signature server, the e-mail sender enters account set up information.
Account set up information includes information about the e-mail sender and the layout and
content of an e-mail signature. The user computer transmits the account set up information to a
5 signature server via the Internet.

Once the e-mail sender provides the account setup information to the signature server, in
Block 23 the signature server generates a tag for the e-mail sender to place in the body of the e-
mail sender's e-mail. The tag contains a location of the signature generation process, an
instruction file location, and other information used by the signature server to generate signature
10 content. In one embodiment, the e-mail sender places the tag in the e-mail sender's e-mail either
by hand, or by placing the special tag in the automatic signature feature that some e-mail
composers offer. In Block 25, the e-mail sender sends the e-mail to a server such as that of their
Internet service provider (ISP), or their online mail server. The e-mail sender's server then sends
the e-mail through the Internet to a reader's server. The reader's server forwards the e-mail to
15 the reader's computer, which includes or accesses e-mail software. The reader's server is also
typically either an ISP, or an online mail server. In Block 27 the signature server receives a
request from the reader's e-mail software to generate signature content for the e-mail. This
occurs when the reader attempts to read the e-mail sender's e-mail. In Block 29 the signature
server generates the signature content by compiling the elements selected by the e-mail sender
20 in the format specified by the e-mail sender. In Box 31, the signature server communicates the
signature content to the e-mail reader.

Thus, the process of FIG. 26 provides for the definition and generation of signature
content for e-mails. In order to further understand details of the process of FIG. 26, however, it
is first appropriate to examine an example of a signature portion generated in accordance with
25 the present invention.

FIG. 2 illustrates an embodiment of e-mail content with different element types. In the
described embodiment, the e-mail content as described for exemplary purposes, is content for a
signature portion 30 of an e-mail message. A signature portion may contain multiple fields with
different types of elements in each field. Each element type corresponds to a different signature
30 functional mode. Each type of element may be composed using different types of content. The
content of each element may be represented using different presentation media supported by
Internet based applications. Supported presentation media include text, images, audio, graphic
animations, and video.

One element type is a static element. The content of a static element does not change
35 each time the signature is used. Address field 33 of the signature contains a name and address
for e-mail sender 1010 (FIG. 1) and is an example of a field with a static element. The content
of the address field is always the same, as illustrated the e-mail or physical address of the e-mail
sender. The media used for presentation may be simple text as shown in the signature or it may

1 be a graphic such as a map with a star indicating the physical location of the e-mail sender. Thus
content is independent of the presentation media.

Poem of the day field 35 of the signature contains a dynamic element. The content of the
dynamic element, as illustrated, is a poem of the day. A dynamic element contains content that
5 is up-dated each time an e-mail containing the signature is opened by an e-mail client and read
by a recipient. For example, the poem of the day is changed each day and the poem of the day
is placed into the signature each time the signature is used.

Third party field 37 of the signature contains another dynamic element. The content for
the third party field comes from, or is derived from information provided by, a third party. The
10 third party field of the signature contains, as illustrated, a stock quote in the signature. In this
example, the signature server communicates with a stock quote service via the Internet to retrieve
a specific stock quote each time the e-mail is opened. In alternative embodiments, third party
content servers may provide any type of content suitable for inclusion in a signature.

In an alternative embodiment, the signature server provides the e-mail sender with the
15 option to include scrolling elements in the signature. Both dynamic and static elements may
comprise scrolling elements. Scrolling elements allow increased amounts of information for
display in the area of the signature. The signature server, as later described, builds time based
scrolling elements, where the entire text or graphic in the scrolling box changes after a given
amount of time. Alternatively, the signature server builds elements with crawling text such as
20 in a stock ticker. In another embodiment, the scrollable area is controlled by the e-mail recipient
through scroll bars. In some embodiments, signatures contain application link elements to
other applications allowing a recipient e-mail client to invoke an application and send an
argument to the invoked application. An application link is sometimes referred to as a "hotlink".

In this way, a recipient of an e-mail message with a signature containing an application link
25 element may select the application link and be immediately connected to an external application
outside of the e-mail client. An exemplary external application is a Web browser that is
connected to a commercial Web site.

Advertisement field 39 of the signature contains an application link element. The
30 contents of the application link element include a link to an advertiser's Web site. The link
enables an e-mail recipient to select the advertisement thus invoking a Web browser that will
immediately connect to the advertiser's Web site.

A use of both dynamic and application link elements is shown as contact field 32. The
contact field contains a dynamic element 31 that indicates whether or not the e-mail sender is
35 currently available for immediate communication. The contact also contains an application link
element 34 that invokes an application capable of establishing a communications link with the
e-mail sender. Exemplary communications applications are "chat" applications allowing two-
way real-time text based communication over the Internet and Voice Over Internet Protocol

1 (VoIP) applications that allow two-way real-time verbal communications over the Internet.

5 FIG. 3 is an object diagram of software objects implementing e-mail content having static elements. Again, for purposes of example, the e-mail content is described with respect to a signature portion of an e-mail. As illustrated in FIG. 3, sender e-mail client 1125 sends e-mail messages 1120 containing links to signature portions to recipient e-mail client 1170 via sender e-mail server 1115 and recipient e-mail server 1105. An e-mail sender uses sender signature client 1130 to compose e-mail content, for an e-mail signature as described, using composition dialog 1155 served by signature server 1160. The signature server also provides an installer software object for installation of signature tags for use by the sender e-mail client or the sender signature client. The signature server sends signature 1165 to the recipient e-mail client when the recipient e-mail client processes the e-mail messages and requests the signature using the links.

15 A type of service performed by the objects depicted in FIG. 3 includes sending signatures with graphics. For example, a e-mail sender composes a signature including graphics using the composition dialog, sender signature client, and an application served by the signature server. The sender e-mail client sends email messages with links to graphics stored and served by the signature server. In one embodiment, e-mail messages are composed and sent to the recipient e-mail client using the sender e-mail client. The contents of the e-mail messages include links to the graphics stored and served by the signature server. The recipient e-mail client requests and receives the stored graphics from the signature server whenever the e-mail client reads the e-mail messages containing the links to graphics on the signature server.

20 FIG. 4 is a deployment diagram for the software objects depicted in FIG. 3. Each of the depicted hosts may communicate via Internet 1200. The Internet is an open communications network composed of nodes communicating with each other using the Transmission Control Protocol/Internet Protocol (TCP/IP) suite of networking protocols. Application layer protocols are added on top of the TCP/IP suite to allow applications to communicate with each other using application domain specific protocols. For example, nodes hosting e-mail clients typically communicate with nodes hosting e-mail servers using one of several application protocols such as the Post Office Protocols (POP). Nodes hosting e-mail servers commonly communicate with each other using the Simple Mail Transfer Protocol (SMTP). The client and server nodes communicating over POP and SMTP communications links collectively create an e-mail message network which may be used to send e-mail messages between a sender and a plurality of recipients. The Internet may be used to implement communication application protocols other than the e-mail specific protocols POP and SMTP. Another high level protocol implemented on the Internet is the Hyper Text Transfer Protocol (HTTP) which may be positioned on top of the TCP/IP layers in a similar way as the POP and SMTP suites. The HTTP suite is used to send documents written in Hyper Text Markup Language (HTML) between software objects over the Internet. The software objects on the Internet which communicate using HTTP, the HTML

1 documents these software objects exchange, and the nodes which host the software objects are collectively known as the World Wide Web (Web).

As illustrated in FIG. 4, sender host 1250 hosts sender e-mail client 1125 and sender signature client 1130. The sender host is operatively coupled to the Internet via sender host communications link 1245. The sender host communications link is adapted to support HTTP and POP communications protocols. Recipient host 1220 hosts recipient e-mail client 1170. The recipient host is operatively coupled via recipient host communications link 1215 to the Internet. The recipient host communications link is adapted to support HTTP and POP communications protocols. Sender e-mail server host 1260 hosts sender e-mail server 1115. The sender e-mail server host is operatively coupled to the Internet via sender e-mail server host communications link 1255. The sender e-mail server host communications link is adapted to support SMTP and POP communications protocols. Recipient e-mail server host 1210 hosts recipient e-mail server 1105. The recipient e-mail server is operatively coupled to the Internet via recipient e-mail server communications link 1205. The recipient e-mail server communications link is adapted to support SMTP and POP communications protocols. Signature host 1225 hosts signature server 1160. The signature host is operatively coupled to the Internet via signature host communications link 1230. The signature host communications link is adapted to support communications protocols including HTTP and File Transfer Protocol (FTP). Third party host 1240 hosts third party content server 1145. The third party host is operatively coupled to the Internet via third party host communications link 1235. The third party host communications link is adapted to support communications protocols including HTTP and File Transfer Protocol (FTP).

FIG. 5 is a diagram of an exemplary architecture for a general purpose computer capable of serving as a host. Microprocessor 1300, comprised of a Central Processing Unit (CPU) 1305, memory cache 1310, and bus interface 1315, is operatively coupled via system bus 1380 to main memory 1320 and I/O control unit 1375. The I/O interface control unit is operatively coupled via I/O local bus 1370 to disk storage controller 1345, video controller 1350, keyboard controller 1355, network controller 1360, and Input Output (I/O) expansion slots 1365. The disk storage controller is operatively coupled to disk storage device 1325. The video controller is operatively coupled to video monitor 1330. The keyboard controller is operatively coupled to keyboard 1335. The network controller is operatively coupled to communications device 1340.

Computer program instructions implementing a software object are stored on the disk storage device until the microprocessor retrieves the computer program instructions and stores the computer program instructions in the main memory. The microprocessor then executes the computer program instructions stored in the main memory to implement the software object. The exemplary general purpose computer is operatively coupled to Internet 1200 (FIG. 4) via the communications device.

FIG. 6 is a sequence diagram depicting the main sequence of communication between the

1 exemplary software objects of FIG. 3. E-mail sender 1010 uses sender signature client 1130 and
signature server 1160 to compose a signature. The sender server serves a series of HTML
documents 1405 to the sender signature client. The HTML documents implement a user interface
for a composition application hosted by signature server host 1225 (FIG. 3). The e-mail sender
5 makes composition selections 1400 that determine the format and content of a signature.

Once a signature is composed, the signature is stored 1410 on the signature server. The
signature is stored as a set of signature portion content generating instructions. The content
generating instructions are used to compose the desired signature that is sent as a response to a
signature request. A signature tag is generated indicating where the signature is located. The tag
10 is embedded into an e-mail message so that when a recipient e-mail client reads the e-mail
message, the recipient e-mail client reads the signature tag. The signature tag directs the recipient
e-mail client to access the signature server to receive the actual signature. The signature tag
contains a command telling the recipient e-mail client to access the signature server at a particular
location, and specifies the file and location to be accessed. For example, in one embodiment the
15 tag is of the form: `<SCRIPT LANGUAGE = "javascript" SRC =
"http://www.signatureserver.com/ ?signatureaccountname"></SCRIPT>`. This command tells
the recipient e-mail client to go to the location "www.signatureserver.com" and load the file
"signatureaccountname". Additionally, the tag contains information or instructions for the
signature server. In an alternative embodiment, the tag contains a section with information to
20 display if the recipient e-mail client cannot access the signature server. Alternatively, the tag
transmits certain variables used by the signature server, including the type of e-mail software
being used, the name of the e-mail recipient, and whether the e-mail recipient uses the signature
server for the e-mail recipient's own outgoing e-mail messages. In another embodiment, the
signature tag comprises an HTML table specifying the content to be obtained from the signature
25 server. If possible the recipient e-mail client begins the process of generating the signature.

The sender signature client receives an installer software object from the signature server.
The installer software object contains instructions for placing signature tags on the sender e-mail
client's host in the signature area of the sender e-mail client. The sender signature client uses the
installer software object to save 1420 the signature's tag on the signature server's host in a
30 location accessible to sender e-mail client 1125. The signature is now ready for use in an e-mail
message.

The e-mail sender enters e-mail content 1415 into the sender e-mail client. The sender
e-mail client retrieves 1425 the signature tag and adds the signature tag to the e-mail content to
create e-mail message 1430. The sender e-mail client sends the e-mail message to sender e-mail
35 server 1115. The sender e-mail server forwards the e-mail message to recipient e-mail server
1105. The recipient e-mail server holds the e-mail message until e-mail recipient 1000 makes
e-mail selection 1440 using recipient e-mail client 1170. The recipient e-mail client creates e-
mail request 1435 and sends the e-mail request to the recipient e-mail server. The recipient e-

1 mail server sends the e-mail message to the recipient e-mail client. The recipient e-mail client
displays 1445 the e-mail content contained within the e-mail message. The recipient e-mail client
uses the link to the signature to send signature request 1450 to the signature server for the
signature composed by the e-mail sender. The signature server generates 1455 signature 1460
5 and sends the signature to the recipient e-mail client. The recipient e-mail client displays 1465
the signature.

In an alternative embodiment, the signature tags are stored by the signature server in a
location accessible to the sender e-mail server. The signature tags are added to outgoing e-mail
messages by the sender e-mail server. The sender e-mail server may accessed by the e-mail
10 sender using any e-mail client on the Internet and the outgoing e-mail messages from the e-mail
sender will contain a signature tag.

In an alternative embodiment, the sender e-mail client is a hosted application accessible
via the Internet using the sender signature client. The user interface for the sender e-mail client
is implemented using documents written in a markup language such as HTML. These documents
15 are linked to create a user interface operable by a sender, over the Internet, using a Web browser
such as the sender signature client. A companion application invoked by the sender signature
client, commonly termed a control or a plug-in, inserts signature tags in out going e-mail
messages before the e-mail messages are received by the sender e-mail client.

The signature portion is set up during account configuration, and may thereafter be further
20 edited by the e-mail sender. FIG. 27 illustrates a flow diagram of a process for configuring an
account. The signature server receives a request from a e-mail sender through the Internet for
a first screen 41. The request is initiated by the e-mail sender contacting the signature server via
the Internet. The signature server responds to the request by sending a first screen 41 through the
Internet to the e-mail sender. The first screen requests that the e-mail sender indicate if they wish
25 to open a new account. Using their browser, the e-mail sender selects "new user", provides a user
name, and requests a first account edit screen.

A first account edit screen is provided to the e-mail sender by the signature server, and
the first account edit screen prompts the e-mail sender to select attributes for their signature, and
also provides the e-mail sender with the option of using a standardized signature. The use of a
30 standard signature, which may be edited or personalized by the e-mail sender, allows the e-mail
sender to quickly and easily begin using the capabilities provided by the signature server. If the
signature server receives a selection from the e-mail sender to have a signature created for them,
the signature server generates a signature for the e-mail sender. More specifically, in one
embodiment an automatic signature generation process includes a CGI script (or program) which
35 processes the request for an automatically generated signature. In the described embodiment each
e-mail sender is provided a signature file, or signature space, on the signature server. The
signature file corresponds to the representation, or indication, of the e-mail sender's signature.
Accordingly, the CGI script copies a default signature file into the e-mail sender's signature space

1 on the signature server.

In one embodiment the signature incorporates three equally sized fields. The identity that the e-mail sender provided to the signature generation process is placed in a first field. A simple predefined graphic is placed in a second field. A single color is placed in a third field.

5 In another embodiment the signature server generates a default signature design. In generating the default signature design, the signature server accesses generates HTML code to render the basic signature structure and to render each field of the signature.

Alternatively, the signature server randomly selects elements in a database of one or more of colors, designs, fonts, and content elements.

10 Further, alternatively, the signature server selects elements in a database of one or more of colors, designs, fonts, and content elements based on preferences of the e-mail senders. These preferences may be known from a profile form that the e-mail sender previously completed. Furthermore, the preferences of the e-mail sender may be known because the e-mail sender was provided from a third party source. Additionally, the e-mail sender's preferences may be known
15 because they were ascertained over time by watching the usage patterns of that e-mail sender.

In an additional embodiment, the first account screen provides the e-mail sender with the option of having a signature designed for them with reference to a particular theme that the e-mail sender chooses. The signature server presents the e-mail sender with the option of choosing, for example, a nature theme, or a specific movie theme. Once the signature server receives a theme
20 selection from a e-mail sender, the signature server accesses a database to incorporate theme specific elements. In one embodiment of the present invention, the signature server selects theme elements from the database by searching through the fields of the records in the database for terms matching the theme. In one embodiment of the present invention, the search is conducted as a query in Microsoft Access. The theme elements include, for example, specific fonts, colors,
25 designs, hotlinks, quotes, advertisements, animations, sounds, and videos.

In construction of the default, random, or theme signatures by the signature server, the signature server prompts the e-mail sender to enter personal information. In a preferred embodiment of the present invention the signature server acquires a e-mail sender's personal information by tracking the e-mail sender's IP address or other means without the e-mail sender's
30 conscious intervention, so that the e-mail sender's personal information is automatically filled into the signature file.

The first account edit screen also prompts the e-mail sender to build a signature themselves. If the signature server receives a selection from the e-mail sender that they wish to build a signature themselves, the signature server prompts the e-mail sender to select attributes
35 for their signature. Accordingly, the signature server provides the e-mail sender with a checklist of signature attributes in order for the e-mail sender to choose the characteristics of the signature.

Thus, in Block 43, the signature server prompts the e-mail sender to choose a size of the

1 signature area. The e-mail sender may select from a list of possible sizes or may specify their
own. The signature server also prompts the e-mail sender to choose the number of different
fields the signature contains, and the size of each of the fields. In the signature area shown in
FIG. 2, four different fields have been selected by the e-mail sender. The e-mail sender's choices
5 are stored in a e-mail sender file. In one embodiment of the present invention, the e-mail sender
file is contained in a memory device accessible by the signature server. In another embodiment
of the current invention, the e-mail sender file is a record contained in a database that is contained
in a memory device accessible by the signature server.

10 Additionally, the first account edit screen provides the e-mail sender a layout template
and prompts the e-mail sender to design their signature from a layout template. In the
embodiment described, the layout template includes a square, round or oval shaped signature
area. In FIG. 2 for example, the e-mail sender selected a rectangular shape. The signatures
in some instances are provided a border. The first account edit screen prompts the e-mail sender
to select a stylized border for the signature area. In FIG. 2, for example, the border is a simple
black line. As shown in Fig. 28 a border 150 for a rectangular signature area is comprised of
15 three portions. A first portion is a corner portion 152 shown between the lines marked "A". As
illustrated in FIG. 28, the corner portion is a right angle corner linking two sides of a rectangle.
In other embodiments, a corner portion is a portion linking two nonlinear elements. For a
rectangular signature, such as the signature illustrated in FIG. 28, there are four corners. In one
embodiment of the present invention and each of the corners are the same, and therefore, are
20 rotated copies of each other. Accordingly, once one corner portion is chosen, that portion is
rotated and copied to produce the other three corners of the rectangle. Alternatively, the e-mail
sender can select up to four different corner designs and colors.

25 A second portion of the border of the signature of FIG. 28 is a vertical side portion 154
shown between the lines marked "B". As illustrated, the vertical side of the signature of FIG. 28
is composed of multiple repeating vertical side portions, called scaled discrete increments. The
height of the vertical side is therefore constrained to heights which are an inter-multiple of the
height of the vertical portion.

30 Similarly, a third portion is a horizontal side piece 156 shown between the lines marked
"C". As long as the rectangular portion is increased or decreased in the horizontal direction in
increments corresponding to the size of the horizontal side portion, the border is made to fit
around the horizontal sides of the rectangle by either increasing or decreasing the number of
repeating horizontal portions, called scaled discrete increments. Once these three different pieces
have been designed, they are adapted to fit on different sized signature blocks.

35 In one embodiment of the present invention, the e-mail sender is provided with a border
editor. During the editing of the signature configuration and content, the signature server
prompts the e-mail sender to edit the border surrounding their rectangular signature file. If the
signature server receives a response from the e-mail sender indicating that they wish to edit their
border, the signature server sends to the e-mail sender a graphic interface, readable by a web
browser, for selecting a border.

1 A process of the border editor is illustrated in Fig. 29. The border editor process presents
the e-mail sender with a choice of vertical side portions to select from in terms of design and
color. The border editor process displays several different vertical side portions and prompts the
e-mail sender to choose one. After the border editor process receives a selection of a particular
5 vertical side portion from the e-mail sender 160, the border editor process presents the e-mail
sender with a choice of horizontal side portions to select from in terms of design and color. The
border editor process displays several different horizontal side portions and prompts the e-mail
sender to choose one.

 After the border editor process receives a selection of a particular horizontal side portion
10 from the e-mail sender 162, the border editor process presents the e-mail sender with a choice
of top, left corner portions to select from in terms of design and color. The border editor process
displays several different top, left corner portions and prompts the e-mail sender to select one.
In an embodiment of the present invention where all of the corners are the same design, after the
border editor process receives a selection of a particular top, left corner portion from the e-mail
15 sender 164, the border editor process generates three additional corner graphics 166. The border
editor process generates a top, right corner graphic by rotating the chosen top, left corner graphic
90 degrees clockwise. The border editor process generates a bottom, left corner graphic by
rotating the chosen top, left corner graphic 90 degrees counterclockwise. The border editor
process generates the bottom, right corner graphic by rotating the chosen top, left corner graphic
20 180 degrees.

 Alternatively, after the border editor process receives a selection of a particular top, left
corner portion from the e-mail sender, the border editor process repeats the corner portion
selection process for the top, right corner portion, the bottom, left corner portion, and the bottom,
right corner portion.

25 In one embodiment, all of the different pieces of each position are the same size
regardless of their color and design. Alternatively, the pieces of each position differ in size
depending on their design and color. In this embodiment the border pieces are chosen before the
size of the signature is chosen. The variations in the size of the signature can then be controlled
to be multiples of the variably sized vertical and horizontal pieces.

30 In an additional embodiment of the border editor process, the e-mail sender is allowed
to form a key and fill border. A key and fill border includes a special portion forming a key in
a length of a border, with the remainder of the border being filled by a uniform or semi-uniform
graphic. The e-mail sender is allowed to choose one or more special portions for an otherwise
uniform border. Thus is formed a uniform border except for the one or more special vertical or
35 horizontal portions. For example, a key and fill border may have a small picture in one vertical
portion of a solid red border.

 In the key and fill embodiment of the border editor process, after the border editor process
receives a selection of horizontal, vertical, and corner portions of the border, the border editor

1 process displays a vertical graphic of the signature file showing a segmented border where the individual portions are separated slightly from each other. The border editor process prompts the e-mail sender to select a key portion to make special.

5 Once the border editor process receives a key portion selection from a e-mail sender, the border editor process stores whether the key portion is a vertical, horizontal or corner portion, as well as a pixel point of reference (for example the top left corner) to begin rendering the key from in a e-mail sender file. The e-mail sender is prompted to select one or more of a graphic, design, and color for the key portion. Once the border editor process receives the one or more elements of the key portion it saves the information to the e-mail sender file. The border editor
10 process then repeats itself until the e-mail sender has made as many key portions as they would like.

A process for rendering the border for a browser is shown in FIG. 30. In order to render the border according to an embodiment of the present invention wherein the border is composed of scaled discrete increments, the signature server first calculates the number of horizontal
15 portions 170. The signature server calculates the number of horizontal portions needed by dividing the width of the signature by the width of the horizontal border portion. The signature server then calculates the number of vertical portions to be used 172. The signature server calculates the number of vertical portions needed by dividing the height of the signature by the height of the vertical portion.

20 In rendering the border for a browser, in one embodiment the signature server creates HTML instructions to form the border. The instructions include code to call up the top, left corner graphic, the number of horizontal portion graphics, and the top, right, corner graphic 174. The signature server then inserts a line break. On the next line, the signature server generates HTML code to call up a vertical portion graphic, then the HTML code to render particular fields
25 of the signature, and then at the end of the second line, the signature server generates HTML code to call up a vertical portion graphic 176. This second line is repeated until the bottom of the signature is reached and all of the fields have code generated for them. Once the bottom is reached, the signature server generates HTML code to call up the bottom, left corner graphic, the number of horizontal portion graphics and the bottom, right corner graphic 178.

30 In the key and fill embodiment of the present invention the border is rendered as described above except that the signature server monitors the generation of the HTML code. When the bordering rendering signature server reaches the pixel point of reference of a key portion, the signature server inserts HTML code to render the key portion instead of the portion that would have been rendered at that pixel point of reference. The signature server then
35 continues to generate the HTML code of the border either until completion, or until another pixel point of reference is reached for another key portion.

In one embodiment, the signature server provides the e-mail sender with the option to select background artwork, upon which text and other content elements are displayed.

1 Additionally, the signature server provides the e-mail sender with the option to choose a style or
theme that will govern many of the elements in the signature, such as the background, colors, and
text font.

5 As shown in FIG. 27, the signature server also provides the e-mail sender a web page
including prompts for the selection of content for each of the fields. In Block 45, the e-mail
sender is prompted to add static content to a field. In Block 47, the e-mail sender is prompted
to add dynamic content to a field. In Block 49, the e-mail sender is prompted to add
advertisements to a field. Once the content of a given field has been determined, in Block 51 the
signature server provides the e-mail sender with the option to edit another field, or to finish
10 editing their signature.

 In a preferred embodiment of the present invention, the signature is composed of several
different blocks that are placed side by side and on top of each other without any special
formatting commands. The relative sizes of each of the fields that make up the signature yield
a cohesive signature after all of the fields have been rendered next to and on top of each other.
15 The design of the signature allows the e-mail sender to choose the shape of the signature, the
overall size of the signature file, and the number and configuration of the fields that make up the
signature.

 In one embodiment, as shown in FIG. 31, the e-mail sender is initially prompted to select
a shape of a signature file 180. The shape that the e-mail sender selects is adjustable. An e-mail
sender is prompted to adjust the overall shape of the signature 182. For example, if the shape of
20 the signature is rectangular, the e-mail sender is prompted to move lines designating the
boundaries of the signature with an input device such as a mouse, i.e. through a "click and drag"
operation. The signature server restricts the increments of adjustment to correspond to the
scaling requirements of content elements or border pieces.

25 Once the e-mail sender has adjusted the shape of the overall signature file, the 184. After
the e-mail sender has selected the number of fields in a signature, the signature server divides the
total signature space into equal pieces. Each of the pieces is a field. The e-mail sender is
prompted to adjust the size of each of the individual fields of the signature 186. In one
embodiment, the graphical environment prompts a e-mail sender to move lines designating the
30 boundaries of each field with an input device such as a mouse.

 The e-mail sender may manipulate both the height and the width of each of the fields such
that the fields form multiple rows and columns, as shown in FIG. 28. In an alternate
embodiment, the e-mail sender is prompted to select the number of rows in their signature file.
After the e-mail sender has selected the number of rows in their signature, they are prompted row
35 by row to enter how many columns they would like in the row. Once the e-mail sender has
selected the number of rows and the number of columns, the e-mail sender is prompted to change
the size of each field 186. The e-mail sender is prompted to edit the height of a given row by
moving lines designating the boundaries of each row with an input device such as a mouse. The

1 e-mail sender is prompted to adjust the width of each of the columns within a particular row, thus forming height and width delimited fields.

5 The e-mail sender is then prompted to add content elements to the field 188. The e-mail sender is prompted to continue to resize and place content in each field until all the fields are edited 190. When a e-mail sender edits an individual field, the contents of the field are selected one by one. For example, a e-mail sender is prompted to select a color for the background of the field; then the e-mail sender is prompted to select a content element for the field; then the e-mail sender is prompted to insert another element for the field. Some elements may be altered by the e-mail sender after insertion into a field, such as changing the color of text after a font has been
10 chosen. In one embodiment of the invention, each time the e-mail sender selects an additional element for a given field, that content element is added to the other elements in a composite format, such as occurs in common drawing programs such as Microsoft Powerpoint, or Microsoft Paint.

15 In one embodiment of the present invention, each element is placed into a graphic space on top of the elements previously added, much as papers are placed on a pile. Once all of the field elements have been added the graphic space is saved pixel by pixel as if taking a picture of the pile from above. A composite of all of the pixels is saved as a graphic. The graphic is sent to an e-mail recipient and displayed by the e-mail recipient's browser. Examples of formats that can be read by a browser include GIF, and JPG.

20 If the e-mail sender creates a field that only contains static elements, then in one embodiment the elements are composited together to form a graphic image. The compositing may take place either at the time of creation or at the time the signature is served to a reader. If the e-mail sender creates a field that contains one or more dynamic elements, then in one embodiment, instructions for acquiring the dynamic element content and formatting the content
25 within the field are stored. Once the signature server receives a request from an e-mail reader for the signature, the signature server acquires the dynamic information, formats the information according to the saved instructions and then generates the elements of the field. Once all of the elements are created, the elements are composited together as described above for static elements.

30 FIG. 7 illustrates how the static elements are placed in a signature. The signature server provides the e-mail sender with a selection list of possible static elements. In Block 53, the signature server receives a static element selection from the e-mail sender. In Block 55, static elements that are generated purely with HTML code are generated by the signature server and placed in a e-mail sender file. Examples of this include bold text, underlined text, and hyperlinks. In Block 57, static elements, such as graphic files, that are not generated by HTML, are assigned
35 by the signature server to a location, and that location is converted into an HTML tag to enable the reader software to find the file. Additionally, in Block 59, the signature server creates HTML format tags so that the reader software properly formats the file within the signature. The HTML format tags instruct the reader software where to put the object in relation to other objects or table

1 cells. In Block 61, the signature server provides the e-mail sender with the option to either create another static element or finish adding static elements.

5 In signature 30 of FIG. 2, address field 33 contains the name and address of the signature holder. This is a static element. The signature server receives the text content from the reader substantially as it appears. The text is formatted by the signature server for size and font, to align to the left of the cell, and to be on 3 different lines by the inclusion of formatting HTML tags.

10 In other embodiments of the current invention, static content may comprise stylized name signatures, animating fonts, specially created fonts, graphical logos, pictures, audio, video, and animations. The signature server gives the e-mail sender the option of either choosing from an existing group of elements or of submitting the e-mail sender's own elements through the Internet. The signature server creates these content elements by creating links to them and formatting them into the signature using HTML formatting commands. The signature server places the links and formatting commands into an e-mail sender file in a location accessible to the signature server. In an additional embodiment, the static element content comprises a link to a file that the e-mail recipient client can simply select to acquire the file. The signature server provides the e-mail sender with the option to modify the file's content.

15 In another embodiment the signature server stores a signature design as tables in a database. The tables are comprised of multiple records, and each record is comprised of multiple fields. The tables in the database include a signature table and a field table. The signature table contains the size of a signature, the shape of the signature, and the number of fields in the signature. The signature table may define these elements for multiple signatures. An example signature is rectangular, 60 pixels vertically, 350 pixels horizontally, and contains four fields.

20 The field table contains a record for each field in each signature defined in the signature table. Each record includes the identification of the signature and field the record relates to, a size of the field, a location of the field, a background color, and information about elements that are placed into each field. The field record also contains information about the specific details that need to be inserted into the field to personalize the default signature for the specific e-mail sender requesting it. Additionally, the field database record for a given field, may contain instructions for the generation of content in that particular field, such as randomly or selectively choosing an advertisement from a database containing multiple advertisements.

25 In generating a signature, the signature server accesses the signature table and generates HTML code to render the basic signature structure. The signature server then accesses the field table and generates HTML code to render each field of the signature.

30 Alternatively, the signature server randomly selects elements in a database of one or more of colors, designs, fonts, and content elements. In one embodiment of the present invention, the signature server randomly selects a record in the signature table to obtain the basic signature size, shape and number of fields. The signature server then randomly selects a font, design, background color, and one or more content elements for each field. In a randomly selected one

1 of the fields, instead of random content elements, the signature server inserts the e-mail sender's personal information.

5 Further, alternatively, the signature server selects elements in a database of one or more of colors, designs, fonts, and content elements based on preferences of the e-mail senders. These preferences may be known from a profile form that the e-mail sender previously completed. Furthermore, the preferences of the e-mail sender may be known because the e-mail sender was provided from a third party source. Additionally, the e-mail sender's preferences may be known because they were ascertained over time by watching the usage patterns of that e-mail sender.

10 In an additional embodiment, signature server provides the e-mail sender with the option of having a signature designed for them with reference to a particular theme that the e-mail sender chooses. The signature server presents the e-mail sender with the option of choosing, for example, a nature theme, or a specific movie theme. Once the signature server receives a theme selection from a e-mail sender, the signature server accesses a database to incorporate theme specific elements. In one embodiment of the present invention, the signature server selects theme
15 elements from the database by searching through the fields of the records in the database for terms matching the theme. In one embodiment of the present invention, the search is conducted as a query in Microsoft Access. The theme elements include, for example, specific fonts, colors, designs, hotlinks, quotes, advertisements, animations, sounds, and videos.

20 In construction of a signature by the signature server, the signature server prompts the e-mail sender to enter personal information. In one embodiment of the present invention, the signature server acquires an e-mail sender's personal information by tracking the e-mail sender using an identifying means such as the email sender's IP address or small files stored and returned by the email sender's Web browser (cookies) without the e-mail sender's conscious intervention, so that the e-mail sender's personal information is automatically filled into the
25 signature file.

In one embodiment, the signature server provides the e-mail sender with the option to select background artwork, upon which text and other content elements are displayed. Additionally, the signature server provides the e-mail sender with the option to choose a style or theme that will govern many of the elements in the signature, such as the background, colors, and
30 text font.

In another embodiment of the current invention, the signature server allows some fields of the signature to be controlled by other e-mail senders. In one embodiment, one section of the signature is controlled by a company. The signature server gives an employee of the company control over certain fields of the signature, but not the section controlled by the company. This
35 enables a company to change its information in the signatures of all of its employees at once.

In one embodiment, the present invention provides a system and method for providing cohesive group wide signatures. The use of cohesive group wide signatures may provide many benefits. For example, corporations may wish to provide a professional image, both within the

1 corporation and without, to those that receive e-mail from persons associated with the
corporation. In addition, control of e-mail signatures allows for presentation of a cohesive image
for a group. Further, e-mail from members of a group may be used to provide advertisements
5 resulting in payments to the group, or may be used to promote products or services associated
with the group. Central control of the signature files allows for increased coverage and control
of the advertising content.

In addition, the signature server may provide services for a single group for tracking
e-mail transmissions by members of the group. For example, each time an e-mail is opened
containing a signature referencing the signature server, a message may be sent to the signature
10 server requesting content. Accordingly, the signature server is able to track the elements
requested by recipients of e-mail, and thereby track overall e-mail generation by members of a
group. In one embodiment, tracking information includes: when and how many times a signature
portion was served; an Internet Protocol (IP) address each of the email recipients; and whether
or not an element was selected from the signature portion by a recipient. This tracking
15 information is made available for further graphical and statistical analysis and may be viewed for
groups of e-mail senders or for a single e-mail sender.

A process of providing an cohesive signature is illustrated in FIG. 8. A manager e-mail
sender first creates a signature template 214. The signature template includes the format of the
signature, the fields of the signature and the elements associated with the signature. Additionally,
20 a field is designated within the signature template for an e-mail sender's name. Accordingly, a
input form is provided to each e-mail sender (216). The input form requests the e-mail sender's
name and title. The form is an HTML input form, and provides requested information to the
signature server by way of a post command (174). Upon receipt of the post, the signature server
executes a program such as a CGI script or invokes a servlet object to generate the signature file
25 (220). The signature file is comprised of the e-mail sender's name and title as well as the
common elements provided in the signature template. The signature file is stored in an area to
which non-manager e-mail sender e-mail senders do not have write access. The signature file
is then provided to the e-mail sender's local machine (222).

In another embodiment of the current invention, the signature server allows an e-mail
30 sender to display part of another signature in their own. The signature server establishes
relationships between signature holders by allowing them to swap content with each other. The
signature server dynamically changes the copying signature, when the original signature changes.
The signature server receives an indication from a first e-mail sender that they wish to
incorporate the content of a second e-mail sender's signature into their own. The signature server
35 creates a pointer in that first e-mail sender's file that points to the second e-mail senders file to
generate the desired content. Thus, whenever the second e-mail sender modifies the content of
that field in their signature, the first e-mail sender receives that modified content.

In one embodiment, the signature server controls one or more fields within a signature.

1 One field of the signature contains a solicitation to get more e-mail senders to use the signature
content generation. The content of this field changes depending on whether or not the e-mail
recipient requesting a signature from the signature server is a current process account holder.
In another embodiment, the signature generation process may couple with another entity and they
5 may jointly control the contents of one or more signature fields. This provides the signature
server with the capability to "co-brand" the signature. For example, as an incentive for a
company to encourage its employees to use the signature generation process, that company may
be identified in the signature of an employee's e-mail along with a signature generation process
identifier. Thus, in one embodiment, the signature server inserts for a group of e-mail sender's
10 signature a content indicating the identity of the co-brand. As will be explained below, the
signature server may track every time the signature is sent with the co-brand's information so that
compensation for displaying the co-brand's information is based on the number of signatures
sent.

FIG. 9 is a sequence diagram illustrating the communication sequence between software
15 objects implementing a dynamic element within a signature. Recipient e-mail client 1170 sends
e-mail request 1435 to recipient e-mail server 1105. The recipient e-mail server sends e-mail
message 1430 in response to the e-mail request. The recipient e-mail client displays 1445 the
contents of the e-mail message. The recipient client sends signature request 1450 to signature
server 1160. The signature server invokes 1505 dynamic content generator 1500. The dynamic
20 content generator generates dynamic content for a dynamic element within a signature. The
dynamic content may be derivable from data directly accessible to the dynamic content generator
such as the time of day. Alternatively, the dynamic content generator may access third party
content server 1145 by sending content request 1510. The third party content server responds to
the content request by sending content 1512 to the dynamic content generator. In one
25 embodiment, the third party server sends the content in a format especially for the dynamic
content generator without extraneous information. In an alternative embodiment, the content is
available from a third party server, but not necessarily in a format or manner directly usable by
the dynamic content generator. In such cases, the dynamic content generator parses 1515
received information as may be necessary to extract the content desired. In cases where the
30 content is prepared and made especially available to the signature server, little or no parsing is
required. In other cases, however, the content may be embedded within an HTML page. The
HTML page may contain significant amounts of data and other information, much of which may
not be pertinent to the purposes of the dynamic content generator.

In another embodiment, the third party content is cached by the signature server. In this
35 embodiment, the signature server polls the third party server on a regular basis thereby keeping
a refreshed copy of the third party content readily available to the signature server.

In another embodiment, the third party content is fed directly to the recipient e-mail client
requesting the signature portion content. In this embodiment, the signature server does not act

1 as an intermediary between the recipient e-mail client and the third party content server.

In another embodiment, the signature server connects directly to a third party database server. The signature server sends one or more queries to the third party database server to acquire content and constructs the signature portion content based on the responses of the third party database server. FIGS. 23 and 24 illustrate how a parsing function works within a dynamic content generator to parse information from a fragment of a document written in a document markup language such as HTML or eXtensible Markup Language (XML). As illustrated, the desired signature portion content is the stock price of "ABC CORP". Referring to FIG. 23, HTML fragment 2220 contains display formatting tags such as tag 2205 specifying how text nodes such as corporation identification text node 2200 are to be displayed by a Web browser. The desired content of the HTML fragment is the stock price of the corporation. The stock price is given in stock price text node 2210 as "66".

Referring to FIG. 24, a parsing function operates on HTML fragment 2220 (FIG. 23) as follows. The parsing function reads in a HTML fragment 2300 containing the name and stock price for "ABC CORPORATION". The parsing function finds 2310 the character string "ABC CORP". The parsing function finds 2320 the next four right angle brackets indicating the end of the next four formatting tags. The parsing function takes 2330 the next text node as the stock price for "ABC CORP". The parsing function formats 2340 the text node into a format suitable for inclusion as content in a signature portion of an e-mail and sends 2350 the formatted stock price to a signature generator. In this way the dynamic content generator uses a parsing function to parse HTML documents to extract the appropriate data for a signature portion.

Referring again to FIG. 9, the dynamic content generator sends dynamic content 1520 to the signature server and the signature server generates 1455 signature 1460. The signature server then sends the signature to the recipient e-mail client. The recipient e-mail client displays 1465 the signature.

In an alternative embodiment, the dynamic content generator may contact a third party server that maintains a database of users connected to the Internet. Such a server is sometimes called a "presence server". A presence server detects whether or not individuals are using applications operatively coupled to the Internet.

FIG. 25 is a flowchart of a process by which a dynamic content generator uses a presence server to create content for a signature portion. The dynamic content generator contacts and queries 2400 the presence server. The dynamic content generator receives 2410 a response from the presence server. The dynamic content generator uses the response from the presence server to determine 2430 if an e-mail sender is currently available to immediately receive an e-mail message or to participate in a real-time chat or VoIP session. If so, the dynamic generator creates 2440 content suitable for use in a signature such as dynamic element 31 of contact field 32 (FIG. 2). If the e-mail sender is available, then exemplary content for the dynamic element is "Online". If the e-mail sender is not available, then the dynamic content generator creates 2420 content for

1 the dynamic element as "Out to lunch".

5 FIG. 10 illustrates an embodiment of the use of a presence server to provide content for a dynamic element. E-mail sender 1010 invokes 1800 sender Internet application 1840. The sender Internet application invokes 1805 sender presence indicator 1845. The sender presence indicator responds to requests sent over the Internet to acknowledge that the sender Internet application is active. Presence server 1850 sends acknowledgment request 1810 to the sender presence indicator as part of polling process 1815. The sender presence indicator sends acknowledgment 1825 to the presence server. The presence server updates 1820 a database of present users to indicate that the e-mail sender is present. In the alternative, if the presence server
10 does not receive an acknowledgment from the sender presence indicator, the presence server updates the database to indicate that the e-mail sender is no longer active on the Internet. This process of polling and updating the database is continuous so that the updated database contains an accurate representation of which e-mail senders are actively using the Internet at any given moment.

15 The updated database is used by the presence server to provide content for a dynamic link in a signature. Recipient e-mail client 1170 sends e-mail request 1435 to recipient e-mail server 1105. The recipient e-mail server sends e-mail message 1430 in response to the e-mail request. The recipient e-mail client displays 1445 the contents of the e-mail message. The recipient client sends signature request 1450 to signature server 1160. The signature server invokes 1505
20 dynamic content generator 1500. The dynamic content generator accesses the presence server by sending content request 1510. The presence server queries 1830 the database of present e-mail senders and responds to the content request by sending content 1512 to the dynamic content generator. The content indicates whether or not the e-mail sender is currently actively connected to the Internet. The dynamic content generator formats 1855 the content into dynamic content
25 1520 suitable for inclusion in a dynamic element. In one embodiment, the dynamic content is in the form of a text string that contains "I'm online, let's talk" when the e-mail sender is available via the Internet. The dynamic content is in the form of a text string that contains "Sorry, try again later" when the e-mail sender is no longer available via the Internet. The dynamic content generator sends the dynamic content to the signature server and the signature
30 server generates 1455 signature 1460. The signature server then sends the signature to the recipient e-mail client. The recipient e-mail client displays 1465 the signature.

FIG. 11 illustrates a process of incorporating dynamic elements into a signature. The signature server provides the e-mail sender with a selection list of possible dynamic elements to incorporate into the signature. In Block 63, the signature server receives a dynamic element
35 selection from the e-mail sender. In Block 65, the signature server generates instructions for acquiring the dynamic element and places the instructions in the e-mail sender file. This instruction, for example, may be a query for locating an item in a database. In Block 67, the signature server generates instructions for generating dynamic content. For example, the

1 signature server may include the date or the time as search criteria to select an element from a
database. In Block 69, once the instructions for finding the element and acquiring a result are
complete, code is created by the signature server and placed in the e-mail sender's signature file
to format the dynamic element in the signature. In Block 71, the signature server prompts a e-
5 mail sender to select another dynamic element or finish selecting dynamic elements.

In signature 30 (FIG. 2) poem of the day field 35 contains a dynamic element. The
signature server prompts the e-mail sender to select the category of poem and provides samples,
but the actual poem that the e-mail recipient sees is whatever poem the signature server selects
based on the day that the e-mail recipient reads their e-mail. In one embodiment, this poem is
10 contained in a file with a constant name, the content of which is updated by a process of the
signature server host on a daily basis. In another embodiment, the poem is contained in a
relational database indexed by the date that the mail is read and the type of poem requested by
the sender. In the latter embodiment, the signature server allows the e-mail sender to specify that
the poem sent to the reader is either dependent on the day the e-mail was sent or the day the
15 e-mail is read.

Additional types of day specific dynamic elements include quotes of the day, jokes of the
day, cartoons of the day, date and day specific elements of a salutation, such as "Happy Tuesday,
May 20, 1999.", and a countdown such as "the number of days until the New Year is ____".

20 Additionally, the signature server calculates several time and date specific items of
information based upon when the e-mail recipient requests signature content and when the e-mail
was sent to the e-mail recipient. In one embodiment, a e-mail sender is prompted by the
signature server to insert a time of day specific element, so that the signature shows a moon and
stars, or is darkened, if the e-mail is being read or sent at night. Additionally, the signature server
prompts the e-mail sender to insert seasonal alterations, such as a snowing signature in the
25 winter, or holiday decorations around the time of a specific holiday.

In additional embodiments, the dynamic content comprises an object with random content
such as an animated fortune cookie that breaks open to reveal a fortune, animated dice that roll,
an animated magic eight ball that shakes and displays an opinion, an animated I-ching that
"rolls", and an animated slot machine with spinning wheels. The result displayed on each of the
30 above objects randomly varies each time the signature is displayed, so that any two e-mail
messages may have different results.

In another embodiment of the current invention the signature server contacts a third party
server to acquire dynamic information. FIG. 12 illustrates a flow diagram of a process executable
by the signature server for placing dynamic third party elements in a signature. The dynamic
35 information may include for example, stock quotes, news tickers, sports scores, movie and TV
program information, or the status of a particular auction. The signature server provides the e-
mail sender with a selection list of possible dynamic elements from third party servers to
incorporate into the signature. In Block 73, the e-mail sender chooses a dynamic third party

1 element from the selection list. In Block 75, the signature server generates instructions on where
to find the third party server and the particular element desired. This includes the IP address of
the server, as well as the specific file to look for on the server. In Block 77, the signature server
generates instructions on how to solicit the particular dynamic content from the third party server.
5 In Block 79, the signature server generates instructions on how to isolate the dynamic content
from all of the information returned from the third party server.

In Block 81, the signature server generates instructions on how to format the content
received from the third party server, or stored locally, so that the content will be correctly placed
into the signature. These instructions are stored in the e-mail sender file. In Block 83, the
signature server prompts a e-mail sender to select another third party dynamic element or finish
10 selecting third party dynamic elements.

In an additional embodiment of the present invention, some third party dynamic content
may be often requested. Accordingly, and in order to provide faster response to e-mail recipients
such data is updated on the signature server on a regular basis. For example, many stock quotes
15 may be often requested. Moreover, up to date stock quotes may be important. Thus, the
signature server may poll the information from third party servers on a regular basis, such as
every thirty seconds or every five minutes. Thus, the signature server may maintain up to date
locally available information regarding these items. In this situation, the signature server
generates instructions on where to find the data from the third party on the local signature server.
20 For example, in some embodiments the information is stored in a file, as opposed to, for
example, a database. The instructions therefore include a file location of the information on the
signature server and a specific file name of a file containing the data.

Thus, as necessary the signature server generates instructions on how to isolate the
necessary elements from all of the information obtained from the third party server and stored
25 on the signature server. The signature server generates instructions on how to format the contents
received from the third party and stored on the signature server so that the contents are correctly
placed in the signature. These instructions are stored in the e-mail sender file.

In one embodiment of the present invention the third party content provider is afforded
the opportunity to advertise in the signature. The signature server inserts a link to the advertiser's
30 designated Web site. In addition, the signature server displays next to the content either the
source of the content or a message from the source of the content.

As an example stock quote field 37 (FIG. 2) is an example of a field containing a third
party dynamic element. When a third party stock quote request is received by the signature server
from the e-mail sender, the signature server stores the location of the stock quoting service in the
e-mail sender file. The signature server also stores the commands used to retrieve a stock quote,
35 as well as the specific stock quote or quotes to retrieve. The signature server stores instructions
to parse the content sent over the Internet from the stock quote server to extract only the content
desired by the e-mail sender. The signature server may also store instructions to format the stock

1 quote into the text of the e-mail sender's signature.

5 In an alternative embodiment, the signature server communicates with other software objects, such as a calendar program. For example the signature server may search a calendar program to see what the e-mail sender has scheduled for the date and time when the signature is requested. The signature server may take information from the calendar and display it as text in the signature indicating where the e-mail sender is. The signature server may also interact with the calendar software to display an e-mail sender's schedule in order to point out when the e-mail sender is free to make an appointment. In another embodiment, the signature server may communicate with a contact manager application so that every time someone in the contact manager alters information in their signature, the information is automatically updated in the contact manager.

10 Signatures may also contain application link elements. Application link elements are used to invoke an application outside of the recipient e-mail client. An application may be hosted by the same host as the recipient e-mail client or may be on a remote host. FIG. 13 is a cooperation diagram illustrating the use a signature to invoke an application outside of a recipient e-mail client. FIG. 13 is similar to FIG. 3 but two new software objects have been added. Recipient e-mail client 1170 receives signature 1165 from signature server 1160. The signature may contain an application link element. The recipient e-mail client uses the application link to invoke 1185 a new application. An exemplary application is recipient client 1195 that communicates with exemplary application server 1620. The application server and the recipient client exchange messages implementing user dialog 1190 for an application hosted at the same site as the application server. In this way, the signature may be used to initiate a new application from within the recipient e-mail client.

15 FIG. 14 is a sequence diagram of a communication sequence when a signature is used to invoke another application. Recipient e-mail client 1170 receives e-mail message 1430 sent by recipient e-mail server 1105. The recipient e-mail client displays 1445 the content of the e-mail message. The recipient e-mail client sends signature request 1450 to signature server 1160. The signature server generates 1455 signature 1460 that is sent to the recipient e-mail client. The recipient e-mail client displays 1465 the signature containing an application link to an application external to the recipient e-mail client. E-mail recipient 1000 selects 1600 the application link. The recipient e-mail server invokes 1605 recipient client 1195. The e-mail recipient uses 1610 the recipient client to interact with application server 1620. The recipient client and application server exchange messages that implement user dialog 1615.

20 FIG. 15 is a sequence diagram of an embodiment wherein dynamic elements and application link elements are combined within a signature to create an interactive application. An example of an interactive application is a live opinion poll whose results appear in the signature and invites e-mail recipients to vote on a topic. In an embodiment, application server 1905 hosts an application accessible to recipient client 1195 over the Internet and acts as a third

1 party server for a dynamic content generator linked to a dynamic element in a signature. After
receiving an e-mail message and displaying the e-mail message contents, recipient e-mail client
1170 sends signature request 1450 to signature server 1160. The signature server invokes 1505
dynamic content generator 1900. The dynamic content generator sends data request 1910 to
5 application server 1905. The application server reads 1945 data 1915 from a memory location
maintained by an application accessible via the Internet through the application server. In one
embodiment, the application conducts a poll, asking users to vote on a topic and storing user
responses in a database. The application server returns data 1915 to the dynamic content
generator in response to the data request. The dynamic content generator formats 1515 the data
10 creating dynamic content 1520. The dynamic content generator sends the dynamic content to the
signature server. The signature server takes the dynamic content and generates 1455 signature
1460. The signature contains a representation of the data taken from the application server and
an application link element containing a link to the application server. The signature server sends
the signature to the recipient e-mail client. The recipient e-mail client displays 1465 the
signature. e-mail recipient makes a selection 1920 of the application link. The recipient e-mail
15 client invokes 1925 recipient client 1195. The recipient client establishes a connection with the
application server and the application server and the recipient client implement a user dialog
1935 with input from user interactions 1930. The application server updates 1940 the data stored
by the application based on the user interactions. The next time a signature request is received
20 the retrieved data will reflect the last e-mail recipients input.

In an alternative embodiment, the tag inserted into the e-mail message contains signature
portion retrieval instructions for constantly retrieving new signature portion contents from the
signature server. In this way, the e-mail message retains an open link with the signature server
and the user does not need to constantly reopen the e-mail message to get new signature portion
25 updates.

In one embodiment of the current invention, the signature server prompts an e-mail sender
to insert an advertisement into the signature. The advertisement may contain an application link
as shown in advertisement field 39 (FIG. 2). FIG. 16 illustrates a process used by the signature
server for incorporating an advertisement into a signature. The signature server provides a list
30 of advertisements that the e-mail sender may add to the signature. In Block 85, the signature
server receives an e-mail sender's advertisement selection. In Block 87 the signature server
generates instructions to locate the advertisement elements. The advertisement elements may be
located on the signature server's host or at a third party content server. Thus, the instructions
may include an IP address of another server as well as the filename of the advertisement. In
35 Block 89, the signature server generates instructions to record each time an advertisement is
placed in a signature. The signature server generates a record in a database every time an
advertisement is attached to a signature and sent to an e-mail recipient. The recording facilitates
later billing of the advertiser for the sending of the advertisement in the signature. In Block 91,

1 the signature server generates instructions to embed the advertisement sender's information in
the advertisement link. Therefore, if the e-mail recipient selects the advertisement, goes to the
advertiser's Web site, and buys something, the advertisement sender receives compensation. In
Block 93, the signature server generates HTML tags to format the advertisement into the
5 signature. The HTML tags function to place the advertisement in the proper field of the signature
and in the correct relationship to other elements in the field. The signature server may also record
that the advertising content is being sent. Recording of the advertisement use allows billing of
the advertiser and compensation to be paid to the e-mail sender if the e-mail recipient selects the
advertisement, goes to the advertiser's Web site, and purchases any items.

10 FIG. 17 is a sequence diagram of another exemplary use of an application link. In this
use of an application link, the invoked application is used to open a communications channel
between an e-mail recipient and an e-mail sender. Recipient e-mail client 1170 sends e-mail
request 1435 to recipient e-mail server 1105. The recipient e-mail server sends e-mail message
1430 to the recipient e-mail client. The recipient e-mail client displays 1445 the e-mail content.
15 The e-mail client sends signature request 1450 to signature server 1160. The signature server
generates 1455 signature 1460 and sends the signature to the recipient e-mail client. The
recipient e-mail client displays 1465 the signature and invokes 1700 recipient communications
application 1180. The invocation of the recipient communications application may include the
location or identification of sender communications application 1135. The recipient
20 communications application invokes 1705 or contacts the sender communications application and
opens communications channel 1140. E-mail sender 1010 and the e-mail recipient are then
connected to each other via the communications channel. Exemplary communications
applications that may be used are chat applications that allow two users to communicate in real-
time over the Internet using text messages and VoIP applications that allow users to communicate
25 to each other over the Internet verbally.

After composing a signature in response to an e-mail sender's content selections for the
signature, the signature server generates a tag for the e-mail sender to insert into the e-mail
sender's outgoing e-mail. The tag tells the recipient e-mail client where to retrieve the signature,
and contains information to enable the signature server to generate the signature. These tags used
30 by the e-mail sender must be made available to the e-mail sender's e-mail client. The way in
which a tag is made available to the e-mail sender's e-mail client is dependent on the type of e-
mail client the e-mail sender is using. Some e-mail clients reside on a host such as a personal
computer and are linked through a Local Area Network (LAN) or the Internet to a remotely
hosted e-mail server. Other e-mail clients are remotely hosted and are reached by an e-mail
35 sender over the Internet using a Web browser. In one embodiment, e-mail sender manually types
the tag into every e-mail message the e-mail sender sends, or if the e-mail sender's e-mail client
allows it, the e-mail sender enters the tag into an automatic signature function.

In an alternative embodiment, the signature server sends the tag to the e-mail sender over

1 the Internet as a file. The signature server directs the e-mail sender to place the file in a location
where the e-mail reader can access the file and append the file contents to an e-mail message.
For example, many e-mail programs have a signature file stored in a particular directory on a
hard-drive that is replaced with the file generated by the signature server. Additionally, the
5 signature server may generate and place a file on the e-mail sender's computer, that will
automatically take an outgoing message and append the signature information to it. In one
embodiment, the signature server on the e-mail sender's computer examines information being
transferred by the e-mail sender's computer to determine whether the information being sent out
is an e-mail. For example, this may be accomplished through parsing outgoing data packets to
10 determine if the outgoing message has the format of an e-mail message.

In one embodiment, a signature client executes on the e-mail sender's local host in a Web
browser's environment and provides an automated method for updating, or synchronizing, an e-
mail sender's signature file on an e-mail sender's host. Synchronization is required when an e-
mail sender's signature area at the signature server is modified. A synchronization process
15 including operations of the signature client is illustrated in FIG. 18. The process of FIG. 18 is
adapted to operate with respect to a COM capable browser, such as Internet Explorer from
Microsoft, and e-mail clients operating on local hosts.

In FIG. 18, the signature server receives a signature from an e-mail sender after the e-mail
sender has completed composing the signature using a Web browser at step 190. Accordingly,
20 in one embodiment the e-mail sender requests an update of the signature area space on the
signature server associated with the e-mail sender through selection of a submit button on a
submit form. Selection of the submit button sends a post message to the signature server. The
signature server includes a server program or script to process the submit command by updating
the signature area space. The signature server responds to the submit request by transmitting
25 program instructions embodying the signature client to the Web browser of the e-mail sender at
step 192.

In one embodiment, the transmitted signature client is an ActiveX control, and the e-mail
sender's web browser serves as the ActiveX container. The signature client is also provided the
contents of the updated signature area on the signature server at step 194. The signature client
30 searches the e-mail sender's local host for signature files. These files are often maintained in
predefined locations, on a e-mail-program-by-e-mail-program basis, and therefore the signature
client searches those areas for signature files. If signature files are not located in those areas, the
signature client searches the entirety of the e-mail sender's host's hard drive for signature files.

After locating the signature files on the e-mail sender's local host, the signature client
35 compares the local signature files with the content provided to the signature client from the
signature server at step 196. If no differences are found the signature client terminates without
making any modifications to the local signature files. If differences are found the signature client
prompts the e-mail sender with a request to update the signature files 198. If the e-mail sender

1 indicates that no updating should occur, the signature client terminates. Otherwise, the signature
client copies the new signature information into the signature files 200. Alternatively, the
signature client allows the e-mail sender to indicate the e-mail programs that should be updated,
and thereafter updates the signature files for those programs without further interaction with the
5 e-mail sender.

In another embodiment, an OBJECT tag from the signature server causes the e-mail
sender's Web browser to format an HTTP request for a file on the signature server containing the
instructions for a signature client in the form of a control. In addition some Web browsers are
not COM capable browsers and are not appropriate containers for ActiveX controls.
10 Accordingly, for such Web browsers, a java wrapper plug-in is used.

In an alternative embodiment, the signature files are stored in an area of the e-mail
sender's host created by the signature client. This mode is useful when the e-mail sender's e-mail
client is hosted by a remote host, with the e-mail sender accessing the e-mail client through a
network such as the Internet using a Web browser. As in the previous embodiment, the signature
15 server provides program instructions in the form of an e-mail control to monitor Web browser
activity. Specifically, the e-mail control monitors Web browser activity to determine if an e-mail
"send" event occurs. For a remotely hosted e-mail client this occurs when a post containing an
e-mail message is sent to the remotely hosted e-mail client. The control intercepts the send event
and modifies the e-mail message before the e-mail message is posted. The e-mail control
20 modifies the e-mail message by taking signature tags stored in the signature files created by the
signature client and inserting these signature tags into the e-mail message.

In an alternative embodiment, no updating of signature files is done at the e-mail sender's
local host. This may be because, for example, the e-mail sender's e-mail client is hosted by a
remote host, with the e-mail sender accessing an e-mail account through a network such as the
25 Internet using a Web browser. As in the previous embodiment, the signature server provides a
control. The control monitors Web browser activity. Specifically, the control monitors browser
activity to determine if an e-mail "send" event occurs. For a mail based e-mail client this occurs
when a post is sent to a Web based mail server. The control intercepts the post, and modifies the
post. The control modifies the post to change its destination to that of the signature server. The
30 signature server thereafter modifies the received message to include the signature information
from the signature server for the e-mail sender, and transmits the e-mail to the intended recipient.

Once complete, the sender sends the e-mail message, including the tag, to a server
connected to the Internet. This server then sends the e-mail message to the recipient mail server
connected to the Internet. The e-mail message resides on the recipient e-mail server until it is
35 retrieved by the recipient e-mail client. In another embodiment of the current invention, the
sender's e-mail server sends the e-mail message to a location where a signature generation
process appends necessary signature information to the e-mail message and then forwards the
e-mail message to the intended recipient.

1 Management of a cohesive signature is modified to permit a manager e-mail sender to
modify signatures but not an individual member of an e-mail sender group. The individual e-mail
sender may either be prompted to manually place the signature file in the appropriate location,
or preferably, the signature file is provided to the individual e-mail sender along with a control
5 to automatically update the e-mail sender's local machine signature file.

Provision of the signature file to the e-mail sender's local machine is not necessary for
server-based e-mail systems. Such systems, accessible by way of a web browser, include
signature files resident on an e-mail server. Accordingly, the manager e-mail sender may make
copies of the e-mail sender signature files on the e-mail server, and does not provide the e-mail
10 senders access to their signature files.

FIG. 19 is a process diagram depicting an embodiment of a process to used by a signature
server to generate a signature. In block 97, the signature server receives a signature request from
a recipient e-mail client and begins processing the signature request. The signature server
accesses the e-mail sender's e-mail sender file, and utilizing the instructions inside, fills the
15 recipient e-mail client's request for a signature. In Block 99, the signature server goes through
different steps to generate the signature, depending on the elements an e-mail sender has selected
for a signature.

In one embodiment of the current invention, the signature includes static elements. As discussed
above, the e-mail sender file contains instructions that the signature server utilizes in acquiring
or generating the various elements that need to be included. The e-mail sender file also contains
20 formatting instructions to enable the signature server to format the static elements.

In another embodiment of the current invention, the signature includes dynamic elements.
As discussed above, the e-mail sender file contains instructions for the things that need to be
calculated to determine the content of the dynamic elements. For example, in an embodiment
25 where the background is dependent on the time of day, the signature server determines the time
and uses the time to search a database of backgrounds sorted by time of day.

In another embodiment of the current invention, the signature contains a dynamic element
that depends upon a third party server. As discussed above, the e-mail sender file contains
instructions for the signature server to retrieve the dynamic content. In the case of dynamic
30 content on a third party server, the e-mail sender file contains the address of the third party
content server, and some parameters of the type of data that are to be obtained from the third
party content server. For example, the e-mail sender file contains the location of a stock quote
service, and the name of the stocks to retrieve quotes on. The signature server accesses the third
party content server through the Internet, acquires the requested content, and formats the content
35 into the signature. Alternatively, if the third party information is stored locally on the signature
server's host, the e-mail sender file contains instruction on where the data is located on the
signature server's host. The e-mail sender file contains instructions on how to extract the
information that the e-mail sender wants in the signature from the third party data. The file also

1 contains formatting instructions so that the dynamic element is displayed properly in the signature.

5 In another embodiment of the current invention the signature contains an advertisement. As shown in Block 101, and discussed above, the e-mail sender file contains process instructions, so that the signature server incorporates the proper advertisements into the signature. The signature server retrieves the advertisement. The signature server registers the transaction in a database that keeps track of which advertisements were sent, who they were sent by, and who they were sent to. The signature server also encodes the advertisement with embedded text to indicate to the advertiser who the sender was.

10 Once the signature server has acquired all of requested elements, the signature server conducts several more steps. In Block 103, the signature server stores the location of the recipient e-mail client and any other information obtained about the recipient e-mail client requesting the signature. Through this tracking procedure, the signature server provides an e-mail sender the ability to see when the e-mail sender's signature (and therefore their e-mail message) was read, as well as trends about when the e-mail sender's messages in general are usually read. In another embodiment, the signature server keeps track of which e-mail recipients have read and which e-mail recipients have not read a particular group e-mail and displays that information as part of the signature.

15 Further, the signature server customizes the information based on the type of e-mail client that the e-mail recipient is using to request the signature. The signature server also customizes the information in the signature based on whether the e-mail recipient is a user of the signature server. The signature server also records all advertisement or third party elements that are included in the signature file to facilitate the billing of the advertisers and third parties for the presence of their content in the signature.

20 As seen in Block 105, the signature server formats the content into HTML and associated files readable by the recipient e-mail client. For example, if the signature contains an address and a picture, the signature server formats the address using HTML tags, and formats the location of the picture in the signature using HTML tags. The signature server also uses HTML tags to tell the recipient e-mail client the file location of the picture so that the recipient e-mail client acquires the picture and integrates it into the signature.

25 In the alternative embodiment using composited graphics, much less formatting is required. The individual graphics are called using HTML tags and HTML coded line breaks are inserted.

30 In Block 107, the signature server sends the signature through the Internet to the recipient e-mail client. The tags in the signature generated by the signature server direct the recipient e-mail client to display the signature in the intended way by instructing the recipient e-mail client how to format the text, which elements to load, and where to load the elements from. In one embodiment, the e-mail recipient may interact with the signature at this point to perform other

1 tasks if the signature server has provided the signature with the capability to accept e-mail
recipient inputs. These tasks include responding to a poll, visiting an advertiser's Web site, and
obtaining a signature server account.

5 FIG. 20 illustrates a block diagram of one embodiment of the signature server. The
signature server includes a new e-mail sender module 109. The new e-mail sender module
performs the functions associated with configuring signature content for an e-mail sender. Thus,
the new e-mail sender module includes processes to setup an account for a new e-mail sender,
including configuring signature content for the new e-mail sender, and also includes processes
to provide for e-mail sender directed modification of existing signature content.

10 In configuring signature content, the new e-mail sender module interfaces with a e-mail sender
file 111, a static element module 113, and a dynamic element module 115. The e-mail sender
file stores signature information. In one embodiment of the current invention, the e-mail sender
file consists of a record in a database. The static element module provides commands to the e-
mail sender file for formatting text and table elements of a signature. The static element module
15 also provides location information of other static objects, including audio, video, and animations,
to the e-mail sender file. The static element module provides formatting information for the
static elements not generated by HTML commands.

The dynamic module provides dynamic element location information to the e-mail sender
file. The dynamic module also provides information to the e-mail sender file to enable the
20 dynamic elements to function. When the content for a dynamic element is located on a third
party server 117, the dynamic element module provides information to the e-mail sender file
including the location of the dynamic element content, as well as any parameters necessary to
acquire the dynamic element content. The dynamic element module also provides information
to the e-mail sender file so that the relevant third party content may be extracted. The dynamic
25 module also provides information for formatting the dynamic elements in the signature.

The signature server includes a signature request module 119. The signature request
module performs the functions associated with generating signature content for a recipient e-mail
client. Thus, the signature request module includes processes to generate static and dynamic
elements for formatted display in a signature. In generating content, the signature request module
30 interacts with the e-mail sender file 111, the static element module 113, and the dynamic element
module 115. The e-mail sender file instructs the signature request module where to locate and
how to format the static elements. The e-mail sender file instructs the signature request module
where to locate, how to use, and how to format the contents of the dynamic elements. The
signature request module also interacts with the tracking module 121 to track requesting recipient
35 e-mail client information, as well as information about the elements incorporated into the
signature, and to facilitate later billing of advertisers and content providers.

In one embodiment of the signature server, content for a dynamic element in a signature
for a particular recipient e-mail client is generated using a recipient profile of the particular

1 recipient e-mail client. For example, in a business setting where each business division receives
a different division signature, the recipient profile comprises a range of addresses of recipients
to whom a particular division signature is to be sent. The contents of a dynamic element within
the division signature comprises information pertinent for a division such as a productivity
5 measurement for that division. In this case, the recipient profile contains the address of each
employee within a division. Each time an e-mail containing the division signature tag is sent
from a manager to an employee in a division, the employee opening the manager's e-mail sees
only that employees's division's productivity measurement.

10 Alternatively, the content of the recipient profile is based on the capabilities of a
recipient e-mail client's host. For example, as previously described, a signature element may
contain both animated graphics and video. However, a recipient e-mail client may only be able
to properly display animated graphics and not video. The signature tag contains instructions for
the recipient e-mail client to construct a recipient profile based on the capabilities of the recipient
e-mail client's host. The recipient e-mail client sends the recipient profile to the signature server
15 along with a signature request. The signature server generates a signature with animated graphics
rather than video so that the returned signature's system requirements matches the capabilities
of the recipient e-mail client's host.

Alternatively, a signature tag contains instructions to collect recipient profile information
from any part of the recipient e-mail client's host.

20 FIG. 21 is a sequence diagram depicting communications within an embodiment of a
signature server wherein content for a dynamic element in a signature for a particular recipient
e-mail client is generated using a recipient profile of the particular recipient e-mail client. The
e-mail sender uses sender signature client 1130 to send recipient profile and signature generation
2000 information to signature server 1160. The recipient profile and signature information
25 adapts the signature server to match a request from a particular recipient e-mail client to a
particular set of signature generation instructions. The signature server saves 2010 the recipient
profile and signature generation instructions. Recipient e-mail client 1170 requests and receives
an e-mail message, and displays an e-mail content within the e-mail message as previously
described. A signature tag within the e-mail message contains instructions for the recipient e-
30 mail client to construct 2015 a recipient profile. In one embodiment, the recipient profile
contains a recipient identification. In another embodiment, the recipient profile contains
information about system capabilities of the recipient e-mail client's host. The recipient e-mail
client sends signature request and the recipient profile 2020 to the signature server. The signature
server generates 2025 signature 2030 based on the contents of the recipient profile.

35 In an alternative embodiment, signature generation based on a recipient profile is
accomplished by modifying an outgoing e-mail message. FIG. 22 is a sequence diagram of
communications within a signature server embodiment wherein outgoing e-mail messages are
modified based on a recipient profile. An e-mail sender uses sender signature client 1130 to send

1 recipient profile and signature tag information 2100 to signature e-mail server 2200. The
signature e-mail server inserts signature tags into e-mail messages and acts as an e-mail server
for sending e-mail messages from sender e-mail client 1125. The signature e-mail server saves
2105 the recipient profile and signature tag information. The recipient profile and signature tag
5 information adapts the signature e-mail server to match a particular recipient with a particular
signature tag. The sender e-mail client sends e-mail content 2110 to the signature e-mail server.
The signature e-mail server selects 2115 a signature tag based on the recipient of the e-mail
content using the previously saved recipient profile and tag identification information. The
signature e-mail server inserts a selected tag into the e-mail content creating e-mail message 2120
10 that is sent by the signature e-mail server to recipient e-mail server 1105 for further routing as
previously described.

In an alternative embodiment, the signature e-mail server and the signature server access
a common history database. The history database includes information about recipient e-mail
client requests. The information about recipient e-mail client requests includes the type of
15 signature content requested by the recipient e-mail client. The signature e-mail server uses the
history database to select the proper type of tags for a particular recipient. For example, a
signature tag may contain information for retrieving dynamic HTML content. However,
whenever a particular recipient e-mail client requests signature content, the request is always for
text content only because the recipient e-mail client cannot process dynamic HTML. In this case
20 the signature e-mail server uses the history database to determine that the recipient e-mail client
has requested only text content. The signature e-mail server then only sends e-mail with tags for
text only signatures.

In an alternative embodiment, the signature e-mail server uses templates for creating
electronic stationary. Templates are created by a user and include header, footer, and body tags
25 for retrieving content from a signature server. The outgoing e-mail message is embedded into
the body of the template and the combined e-mail message and template are forwarded by the
signature e-mail server as a single e-mail message.

In an another alternative embodiment, the signature e-mail server accesses a tag server
over a communications network. The signature server sends a tag request to the tag server for
30 tags. The tag request includes intended recipient information for identifying the intended
recipient of the e-mail message for which the signature e-mail server is requesting a tag. The tag
server uses the recipient information to select the correct tag for the recipient. The tag server
responds to the request for a tag with the selected tag. In this way, a single tag server can server
a plurality of signature e-mail servers.

35 In one embodiment of the signature server, a user is prompted to design and send a
signature to a friend as shown in FIG. 32. Once the process receives the user's selection to
design a signature for someone else 202 the user is prompted to design a signature 204. The
design process proceeds as described above, as if the user was designing a signature for

1 themselves. All of the normal attributes and content elements are available for placement into
the signature, except those that are dependent on person specific software, such as content
elements linked to a personal calendar program. Once the signature is designed, the signature
is saved to a signature file associated with the user. The user is prompted to enter the e-mail
5 address and other known personal information about the recipient 206. Once the process receives
an e-mail address, the process searches to see whether the process already has information about
the recipient 208.

If the recipient of the e-mail has already used the process to generate a signature, then the letter
accompanying the designed signature asks whether the recipient would like to automatically have
10 the signature placed into their e-mail clients 210. If the process receives a response from the
receiver of the signature indicating that they wish to keep the signature, the signature is copied
from the file of the composer, to the file of the receiver. Once in the file of the receiver, the new
signature is accessed just as any other signature in the file, as described above.

If the recipient of the letter has not already used the process, then the user is prompted to
15 open an account 212. If the process receives a response indicating that the signature recipient
wishes to open an account, the process copies the signature from the composer's file to a file
for the recipient, now a member. The process prompts the user to edit the signature that was sent
to them or approve the signature. After the signature is edited to the recipient's satisfaction, the
recipient is prompted to finalize their account in the way that other new users are.

20 The preceding description has been presented with reference to the presently preferred
embodiments of the invention shown in the drawings. Workers skilled in the art and technology
to which this invention pertains will appreciate that alteration and changes in the described
processes and structures can be practiced without departing from the spirit, principles and scope
of this invention.

25 Accordingly, the present invention provides for signature content generation. Although
this invention has been described in certain specific embodiments, many additional modifications
and variations would be apparent to those skilled in the art. It is therefore to be understood that
this invention may be practiced otherwise than as specifically described. Thus, the present
embodiments of the invention should be considered in all respects as illustrative and not
30 restrictive, the scope of the invention to be determined by the claims supported by this
application and their equivalents rather than the foregoing description.

35

1 WHAT IS CLAIMED IS:

- 1 1. A method for generating content for a portion of an e-mail message, comprising:
creating an e-mail content tag for requesting e-mail content;
providing the e-mail content tag for inclusion in an e-mail message;
5 receiving a request from an e-mail client for e-mail content according to the e-mail
content tag; and
sending e-mail content to the e-mail client.
- 10 2. The method of claim 1, wherein the e-mail content further includes an application
link.
3. The method of claim 2, wherein the application link is to a first application in
communication over a communications link with a second application.
- 15 4. The method of claim 3 wherein:
the communications link comprises the Internet;
the first application is a Internet client; and
the second application is an application server.
- 20 5. The method of claim 3 wherein:
the communications link comprises the Internet;
the first application is a chat application; and
the second application is a chat application.
- 25 6. The method of claim 3 wherein:
the communications link comprises the Internet;
the first application is a voice-over-Internet-protocol application; and
the second application is a voice-over-Internet-protocol application.
- 30 7. The method of claim 1, further including:
requesting e-mail portion content from an application;
receiving e-mail portion content from the application; and
generating e-mail content from the e-mail portion content.
- 35 8. The method of claim 7 wherein:
the application is a presence server; and
the e-mail portion content request includes e-mail sender identification data.

- 1 9. A method for generating content for a portion of an e-mail message, comprising:
 creating an e-mail content tag for requesting e-mail content, the e-mail content tag
including recipient profile acquisition instructions;
 providing the e-mail content tag for inclusion in an e-mail message;
5 receiving a request from an e-mail client for e-mail content according to the e-mail
content tag, the request including a recipient profile;
 generating an e-mail content based on the recipient profile; and
 sending the e-mail content to the e-mail client.
- 10 10. The method of claim 9, wherein the recipient profile comprises the address of a
recipient.
11. The method of claim 9, wherein the recipient profile comprises system capability
information of a recipient host.
- 15 12. The method of claim 9, wherein the recipient profile comprises a group identifier
for the recipient.
13. A method for creating and sending an e-mail message, comprising:
20 creating e-mail content generating instructions;
 storing the e-mail content generating instructions;
 creating an e-mail content tag for requesting e-mail content generated according
to the e-mail content generating instructions;
 receiving an e-mail message content and a recipient address;
25 creating an e-mail message using the e-mail message content and the e-mail
content tag;
 sending the e-mail message to the recipient address;
 receiving a request from an e-mail client for an e-mail content according to the
e-mail content tag;
30 generating the e-mail content using the e-mail content generating instructions; and
 sending the e-mail content to the e-mail client.
14. The method of claim 13, the e-mail content generating step further including
insertion of an application link in the e-mail portion.
- 35 15. The method of claim 14, wherein the application link is to a first application in
communication over a communications link with a second application.

- 1 16. The method of claim 15, the e-mail content generating step further including:
 sending an e-mail portion content request to an application;
 receiving e-mail portion content from the application; and
 generating email content using the e-mail portion content.
- 5
17. The method of claim 16 wherein:
 the application is a presence server;
 the e-mail portion content request includes an e-mail sender identification; and
 the e-mail portion content include a presence indication of the of an e-mail sender
10 corresponding to the e-mail sender identification.
18. The method of claim 17, wherein:
 the e-mail content tag further includes instructions for execution by the e-mail
client for building a recipient profile;
15 the request further includes the recipient profile; and
 the e-mail generating step further includes generating an e-mail portion based on
the recipient profile.
19. The method of claim 18, wherein the recipient profile comprises system capability
20 information of a recipient host.
20. A method for generating content for a portion of an e-mail message, comprising:
 receiving a request from an e-mail client for e-mail content according to an e-mail
content tag;
25 generating e-mail content; and
 sending e-mail content to the e-mail client.
21. The method of claim 20, the e-mail content generating step further including
insertion of an application link.
30
22. The method of claim 21, wherein the application link is to a first application in
communication over a communications link with a second application.
23. The method of claim 20, the e-mail content generating step further including:
35 sending an e-mail portion content request to an application;
 receiving an e-mail portion content from the application; and
 using the e-mail portion content to generate the email content.

- 1 24. The method of claim 20, wherein:
 the request further includes a recipient profile; and
 the e-mail content generating step includes generating an e-mail content based on
the recipient profile.
- 5 25. A data processing system adapted to generate content for a portion of an e-mail
message, comprising:
 a processor; and
 a memory operably coupled to the processor and having program instructions
10 stored therein, the processor being operable to execute the program instructions, the program
instructions including:
 creating an e-mail content tag for requesting e-mail content;
 providing the e-mail content tag for inclusion in an e-mail message;
 receiving a request from an e-mail client for e-mail content according to the e-mail
15 content tag; and
 sending e-mail content to the e-mail client.
26. The data processing system of claim 25, wherein the e-mail content further
includes an application link.
- 20 27. The data processing system of claim 26, wherein the application link is to a first
application in communication over a communications link with a second application.
28. The data processing system of claim 27 wherein:
25 the communications link comprises the Internet;
 the first application is a Internet client; and
 the second application is an application server.
29. The data processing system of claim 25, the program instructions further
30 including:
 requesting e-mail portion content from an application;
 receiving e-mail portion content from the application; and
 generating e-mail content from the e-mail portion content.
- 35 30. The data processing system of claim 29 wherein:
 the application is a presence server; and
 the e-mail portion content request includes e-mail sender identification data.

1 31. A data processing system for generating content for a portion of an e-mail message, comprising:

 a processor; and

5 a memory operably coupled to the processor and having program instructions stored therein, the processor being operable to execute the program instructions, the program instructions including:

 creating an e-mail content tag for requesting e-mail content, the e-mail content tag including recipient profile acquisition instructions;

 providing the e-mail content tag for inclusion in an e-mail message;

10 receiving a request from an e-mail client for e-mail content according to the e-mail content tag, the request including a recipient profile;

 generating an e-mail content based on the recipient profile; and

 sending the e-mail content to the e-mail client.

15 32. The data processing system of claim 31, wherein the recipient profile comprises system capability information of a recipient host.

20 33. The data processing system of claim 31, wherein the recipient profile comprises a group identifier for the recipient.

25 34. A data processing system for creating and sending an e-mail message, comprising:
 a processor; and
 a memory operably coupled to the processor and having program instructions stored therein, the processor being operable to execute the program instructions, the program instructions including:

 creating e-mail content generating instructions;

 storing the e-mail content generating instructions;

 creating an e-mail content tag for requesting e-mail content generated according to the e-mail content generating instructions;

30 receiving an e-mail message content and a recipient address;

 creating an e-mail message using the e-mail message content and the e-mail content tag;

 sending the e-mail message to the recipient address;

35 receiving a request from an e-mail client for an e-mail content according to the e-mail content tag;

 generating the e-mail content using the e-mail content generating instructions; and

 sending the e-mail content to the e-mail client.

1 35. The data processing system of claim 34, the e-mail content generating instructions
further including insertion of an application link in the e-mail portion.

5 36. The data processing system of claim 35, wherein the application link is to a first
application in communication over a communications link with a second application.

10 37. The data processing system of claim 36 wherein:
the communications link comprises the Internet;
the first application is an Internet client; and
the second application is an application server.

15 38. The data processing system of claim 36 wherein:
the communications link comprises the Internet;
the first application is a chat application; and
the second application is a chat application.

20 39. The data processing system of claim 36 wherein:
the communications link comprises the Internet;
the first application is a voice-over-Internet-protocol application; and
the second application is a voice-over-Internet-protocol application.

25 40. The data processing system of claim 39, the e-mail content generating instructions
further including:
sending an e-mail portion content request to an application;
receiving e-mail portion content from the application; and
generating email content using the e-mail portion content.

30 41. The data processing system of claim 40 wherein:
the application is a presence server;
the e-mail portion content request includes an e-mail sender identification; and
the e-mail portion content include a presence indication of the of an e-mail sender
corresponding to the e-mail sender identification.

35 42. The data processing system of claim 41, wherein:
the e-mail content tag further includes instructions for execution by the e-mail
client for acquisition of a recipient profile;
the request further includes a recipient profile; and
the e-mail generating instructions further include generating an e-mail portion

1 based on the recipient profile.

43. A data processing system for generating content for a portion of an e-mail message, comprising:

5 a processor; and

a memory operably coupled to the processor and having program instructions stored therein, the processor being operable to execute the program instructions, the program instructions including:

10 receiving a request from an e-mail client for e-mail content according to an e-mail content tag;

generating e-mail content; and

sending e-mail content to the e-mail client.

44. The data processing system of claim 43, the e-mail content generating instructions further including insertion of an application link.

45. The data processing system of claim 44, wherein the application link is to a first application in communication over a communications link with a second application.

20 46. A method using a computer of creating signature content for electronic mail messages comprising:

providing from a server an input form to a remote user computer;

receiving by the server responsive data to the input form communicated from the remote user computer;

25 receiving by the server an identification of a user associated with the responsive data; and

determining by the server a signature content associated with the user.

30 47. The method using a computer of creating signature content for electronic mail messages of claim 46 wherein determining by the server a signature content associated with the user comprises storing an indication of the signature in a memory and accessing the indication of the signature in the memory.

48. The method using a computer of creating signature content for electronic mail messages of claim 47 wherein the representation of the signature content comprises an executable program.

49. The method using a computer of creating signature content for electronic mail messages of claim 47 wherein the signature content includes static content and dynamic content.

1

50. The method using a computer of creating signature content for electronic mail messages of claim 49 wherein determining a representation of the dynamic content comprises executing by the server of a computer program to generate the dynamic content.

5

51. The method using a computer of creating signature content for electronic mail messages of claim 49 wherein determining a representation of the dynamic content comprises requesting information from a third-party server, receiving responsive information from the third-party server, and parsing the responsive information to form the dynamic content.

10

52. The method using a computer of creating signature content for electronic mail messages of claim 51 further comprising transmitting by the server the representation of the signature content to a remote requesting computer.

15

53. A method for customizing an e-mail signature comprising:
creating an e-mail signature format on a source computer;
directing an e-mail reader to the source computer;
generating signature content based on the e-mail signature format; and
communicating the signature content to the e-mail reader.

20

54. The method of claim 53 wherein the creating an e-mail signature format comprises:

contacting the source computer;
selecting elements for the signature format;
storing selected elements in a user area of the source computer.

25

55. The method of claim 54 wherein directing an e-mail reader to the source computer comprises:

obtaining an address for the signature format on the source computer; and
appending the address to an e-mail message.

30

56. The method of claim 55 wherein the generating of the signature content further comprises:

placement of a static signature file element into the signature file;
acquisition of a dynamic signature file element;
placing the dynamic signature file element into the signature file; and
placement of a tracking element into the signature file.

35

- 1 57. The method of claim 56 wherein acquisition of the dynamic element comprises:
 acquisition of information about the e-mail reader;
 acquisition of time sensitive information; and
 acquisition of server computer determined elements.
- 5
58. The method of claim 53 further comprising the compensation of the signature
holder depending on the contents of the signature file.
59. A method for modifying an e-mail message comprising:
10 acquisition of an account on a source computer by an e-mail sender;
 the direction of an e-mail reader to the source computer;
 the source computer generating content of the e-mail message; and
 the source computer communicating the content to the e-mail reader.
- 15 60. A method for modifying an e-mail signature file comprising:
 building a file on a source computer;
 directing an e-mail reader to the file on the source computer;
 modification of the e-mail signature file by the source computer; and
 communication of the signature file to the e-mail reader.
- 20
61. The method of claim 60 wherein the source computer changes the content of the
e-mail signature file depending on a characteristic of a recipient.
62. A server used as part of an e-mail content formation system, the server being a
25 computer system having memory storing data and modules executable by a processor, the server
comprising:
 an account configuration module which configures the server to receive and store
information pertaining to a signature content;
 a reader request module which configures the server to receive a request for
30 signature content; and
 a signature content generation module which configures the server to generate
signature content.
63. The server used as part of an e-mail signature content formation system of claim
35 62 wherein the signature content generation module comprises a static content generation module
and a dynamic content generation module.
64. A method using a computer of incorporating varying content into an e-mail

1 signature portion an e-mail, the signature portion being formed of multiple fields, comprising:
configuring fields of a representation of the signature portion to include static
content and dynamic content;
including the static content in the signature portion;
5 generating the dynamic content;
including the dynamic content in the signature portion; and
transmitting the signature portion to a remote computer.

65. The method using a computer of incorporating varying content into an e-mail
10 signature portion an e-mail of claim 49 wherein the dynamic content is a field in a second
signature portion, the signature portion being for a first e-mail sender and the second signature
portion being for a second e-mail sender.

66. A method of providing thematically appropriate electronic mail signatures, the
15 method comprising:
defining a signature area for multiple users, the signature area being comprised
of fields;
defining signature content for the multiple users for at least some of the fields;
providing the signature area and an indication of the signature content to the
20 multiple users;
receiving a request for signature content; and
providing the signature content.

67. The method of providing thematically appropriate electronic mail signatures of
25 claim 66 further comprising determining a user identification for each user of the multiple users
and defining the user identification of each user of the multiple users as signature content for the
each user of the multiple users for at least one field.

68. The method of providing thematically appropriate electronic mail of claim 67
30 wherein providing the signature area and the signature content to each of the multiple users
comprises transmitting a control to the user local machine for each user of the multiple users and
transmitting the defined signature area and the indication of the signature content to the user local
machine, the control placing the defined signature area the indication of the signature content in
a signature file on the user local machine.

69. A method using a computer of updating a signature file on a user's local machine
35 with signature information maintained on a server, the method comprising:
monitoring a user signature space on the server;

1 determining when the user signature space on the server is updated with signature
information;
providing the signature information to the user's local machine; and
5 updating the signature file on the user's local machine with the signature
information.

70. The method using a computer of updating a signature file on a user's local
machine with signature information maintained on a server of claim 69 wherein the server is
connected to the user's local machine by a network, and further comprising providing a control
10 to the user's local machine, the control performing the updating of the signature file on the user's
local machine with the signature information.

71. A method of creating borders for a signature area for electronic mails comprising:
determining a border element, the border element having a predefined length;
15 determining a signature area, the signature area being constrained in sizes greater
than a minimum size to multiples of the predefined length; and
generating instructions to create a border for the signature area comprised of
multiple border elements.

20 72. The method of creating borders for a signature area for electronic mails of claim
71 wherein the border is comprised of a top, two sides, and a bottom, and the top and the bottom
are each linked to the two sides by corners.

25 73. The method of creating borders for a signature area for electronic mails of claim
72 wherein the top, the two sides and the bottom are comprised of multiple border elements.

74. The method of creating borders for a signature area for electronic mails of claim
73 wherein the corners are predefined graphic elements.

30

35

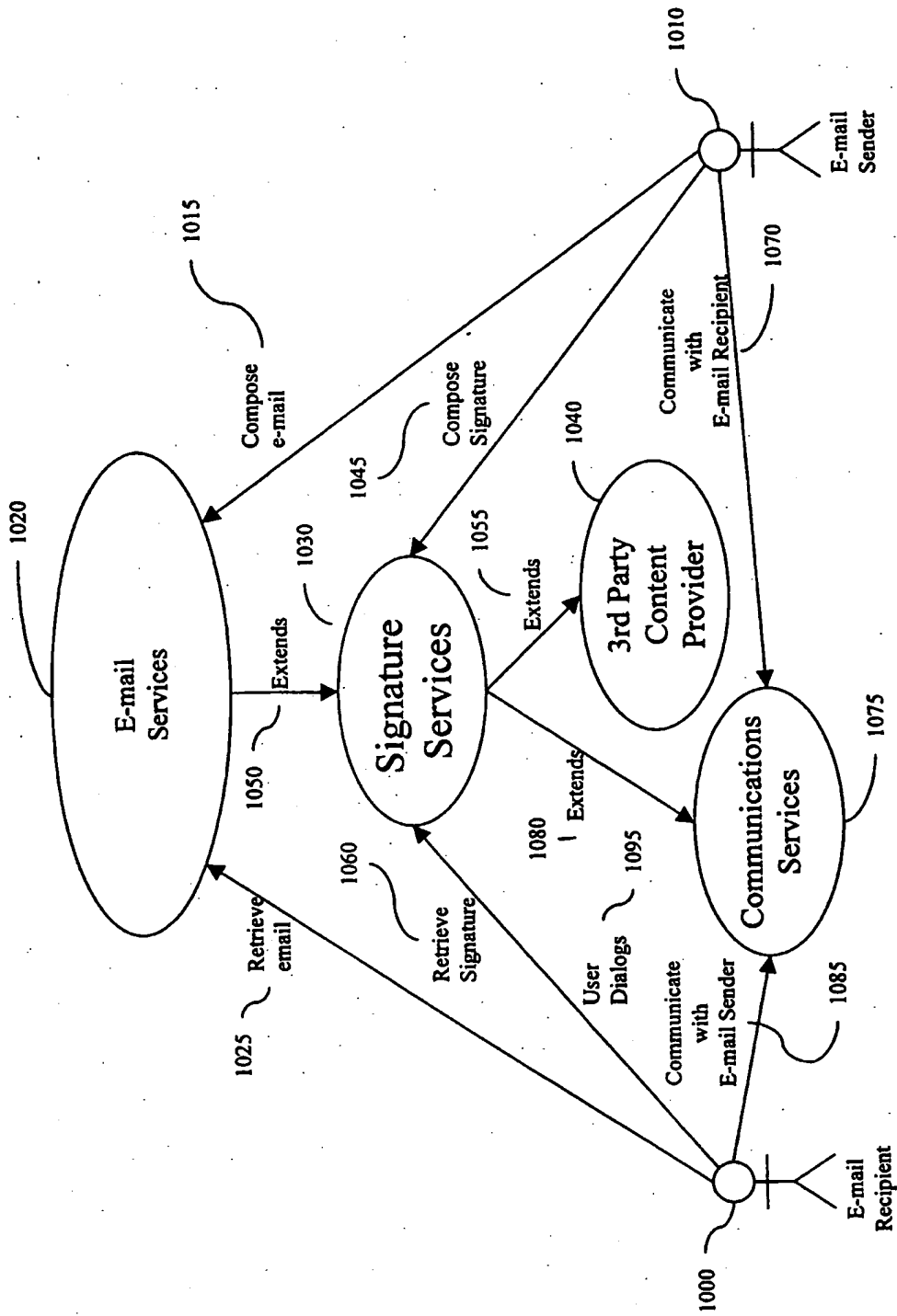

FIG. 1

33 John Smith Synergistic Acme Co. Trinity, NM 90455-0302	35 Poem of the day: "Roses are red, violets are blue. . ."	39 Buy Synergistic Products at <u>WeSell.com</u>
32 Contact		31 I'm online
37 Stock Quote: SACOM +3/4 13.45		34 <u>Please contact me</u>

Fig. 2

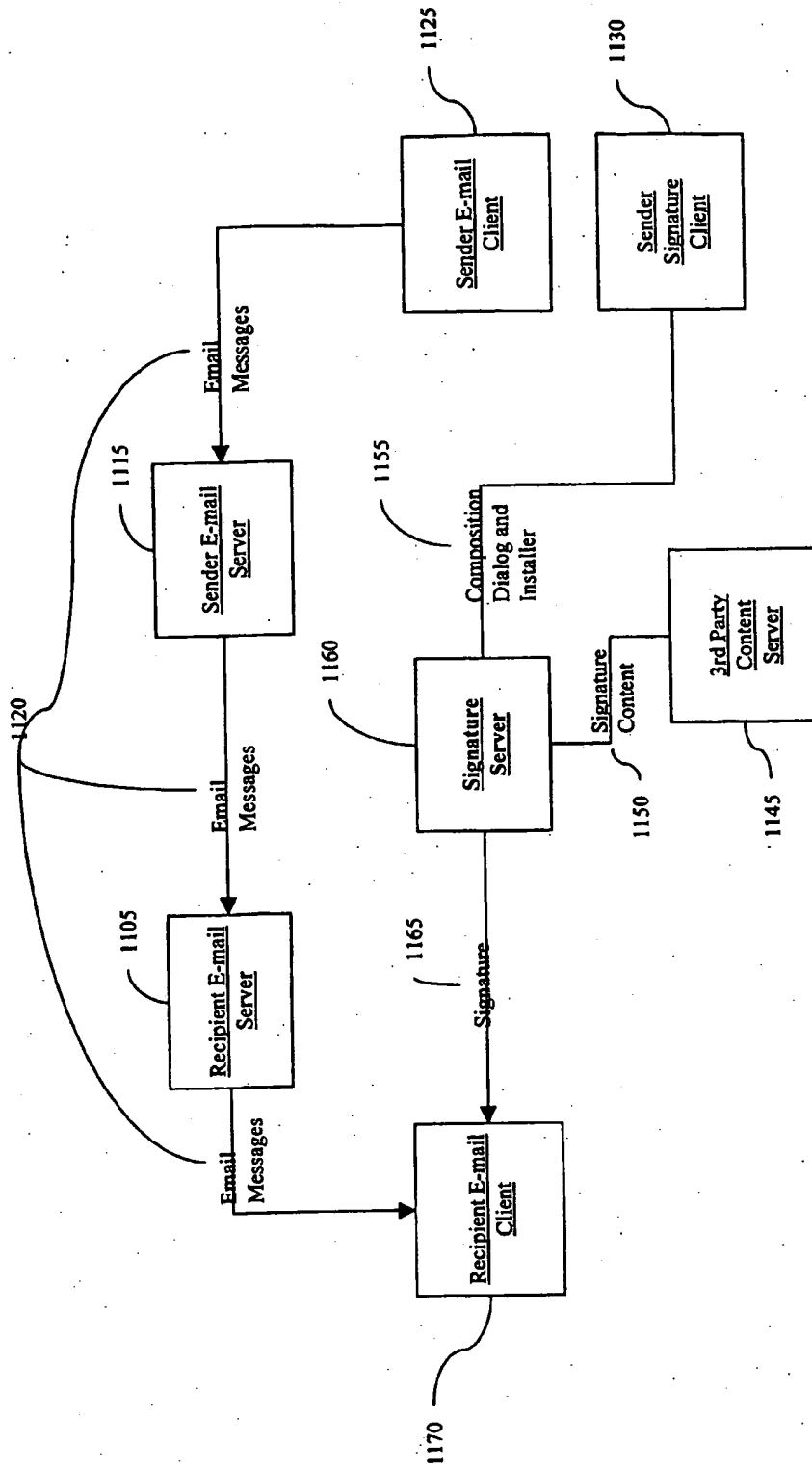

FIG. 3

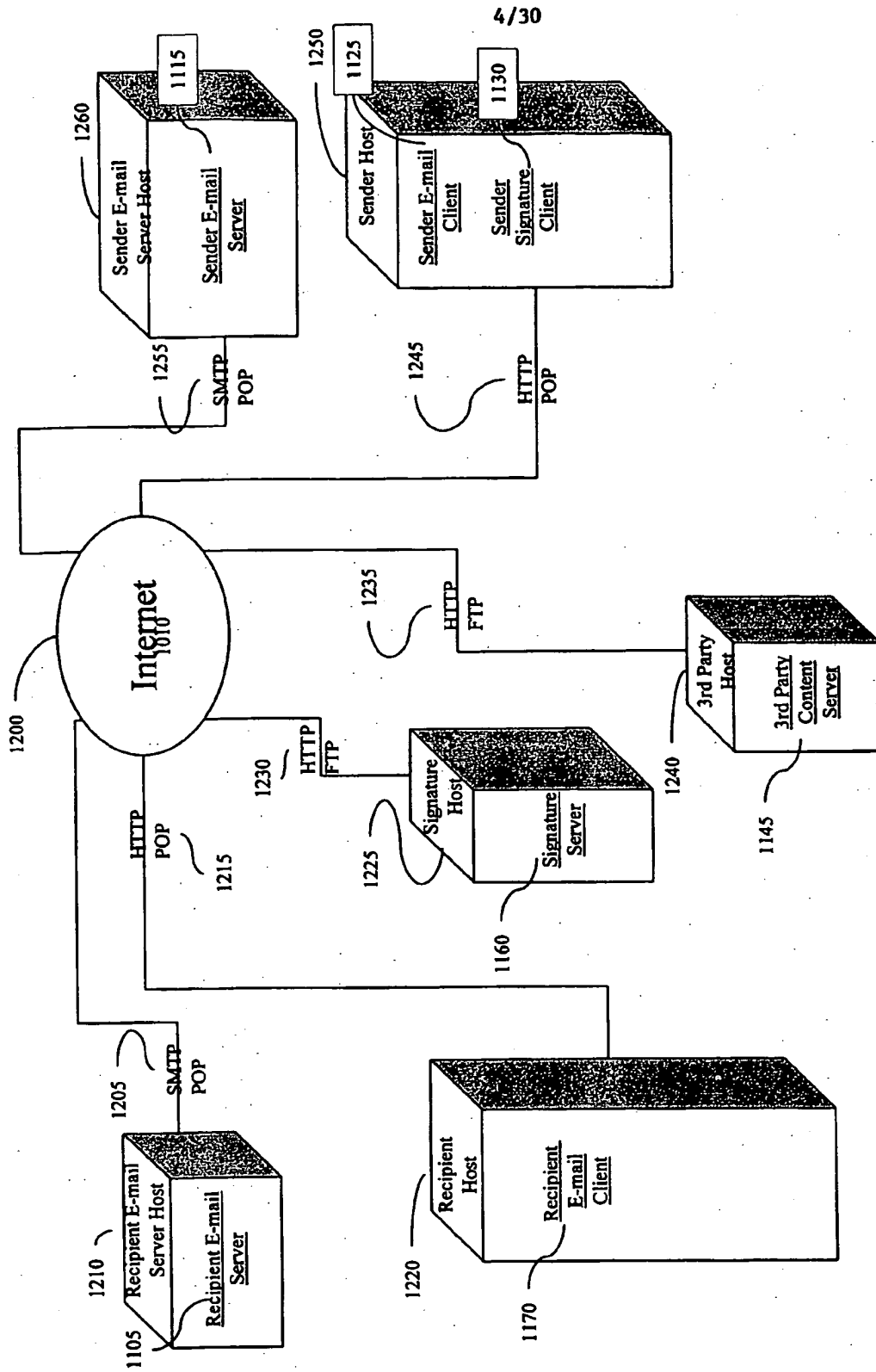

FIG. 4

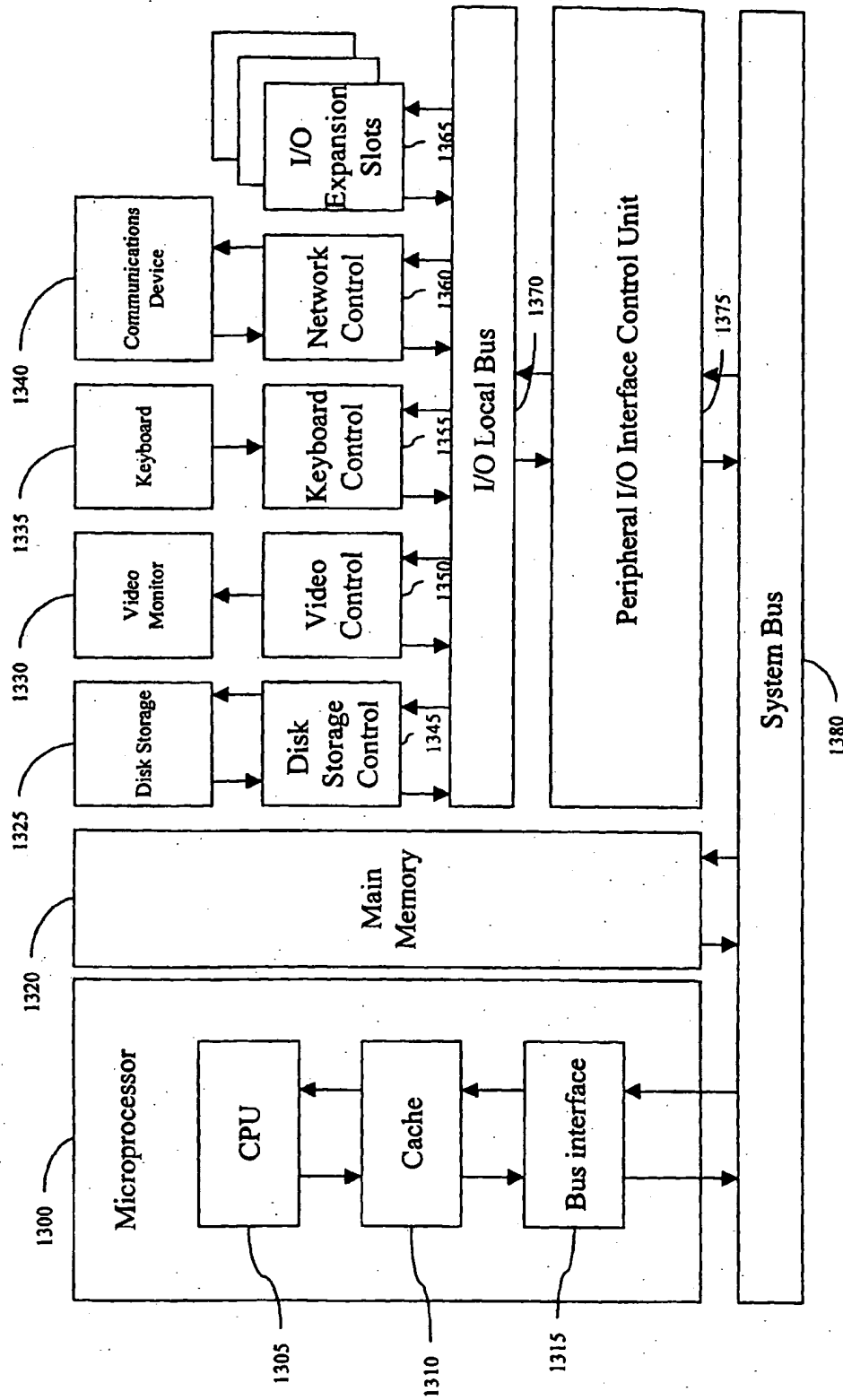

FIG. 5

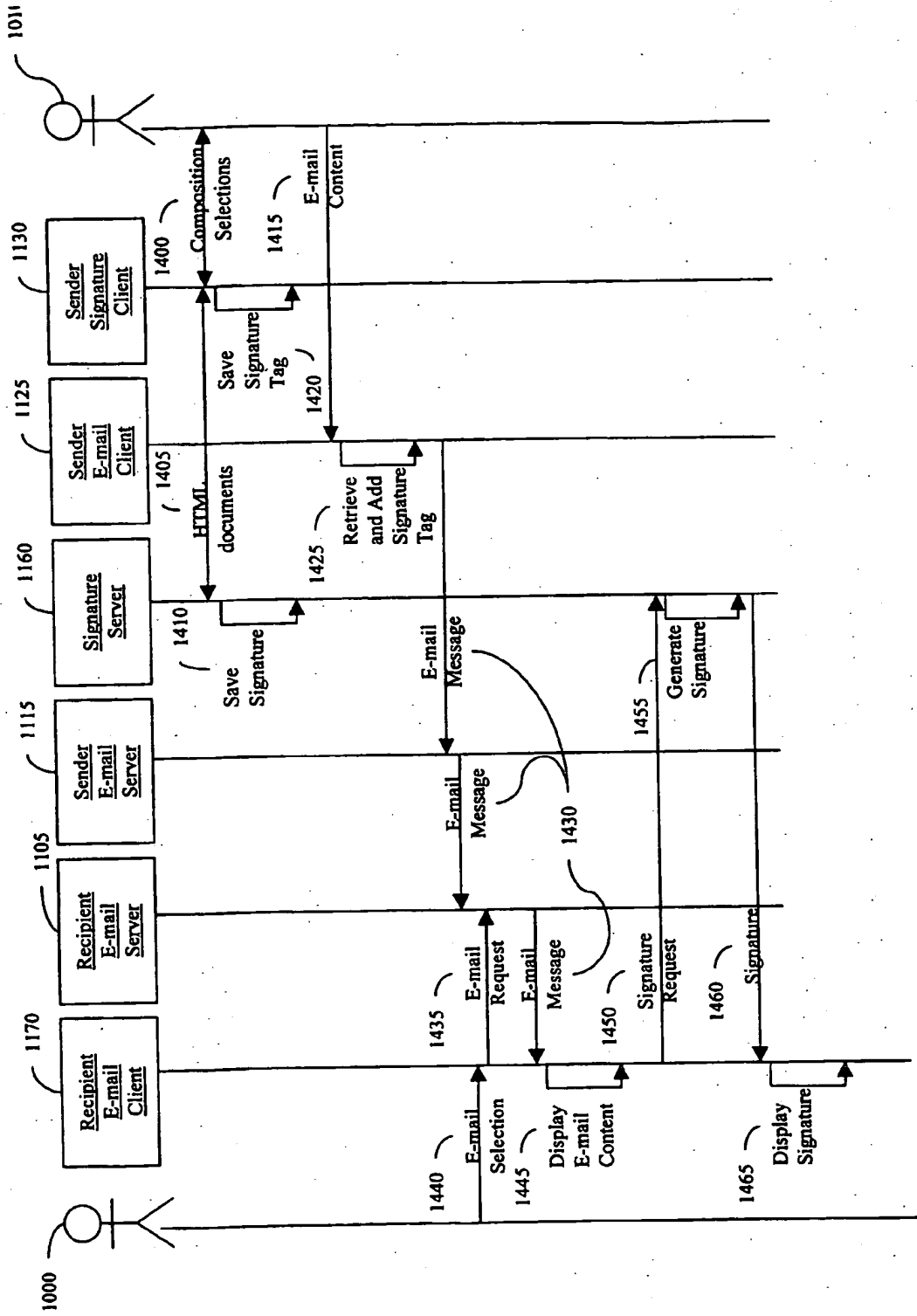

FIG. 6

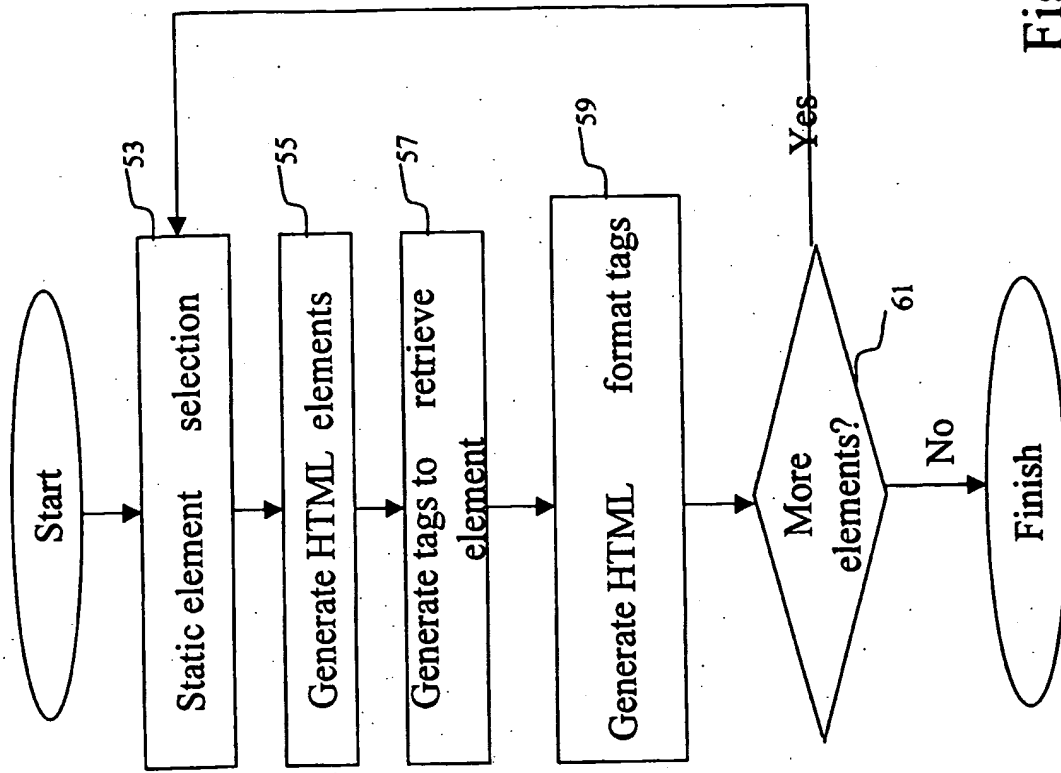

Fig. 7

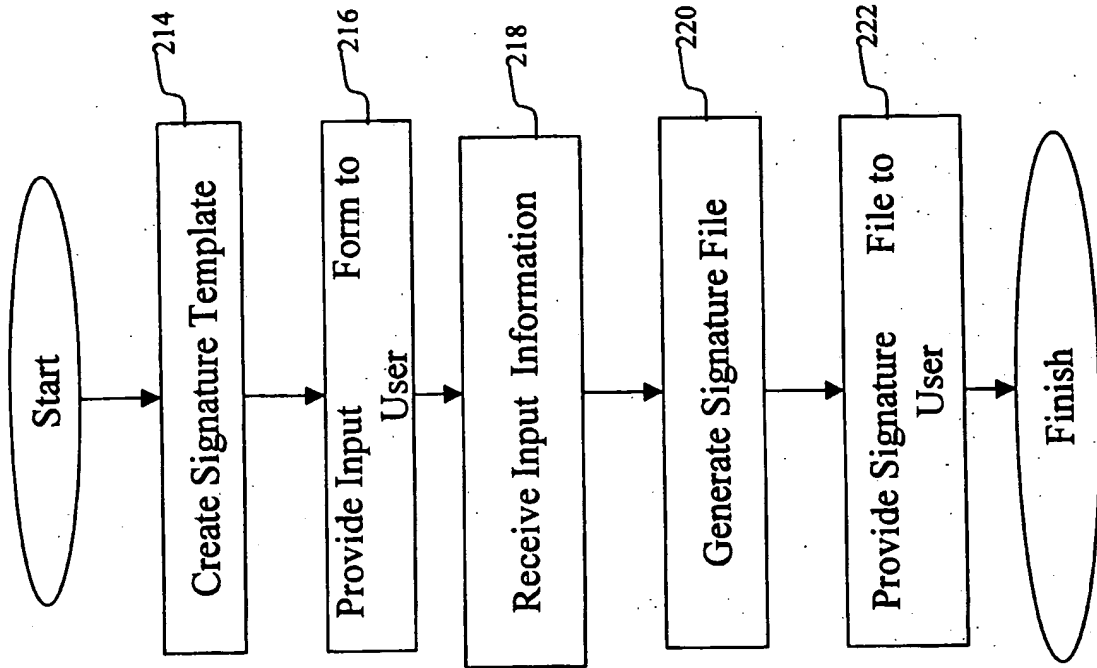

Fig. 8

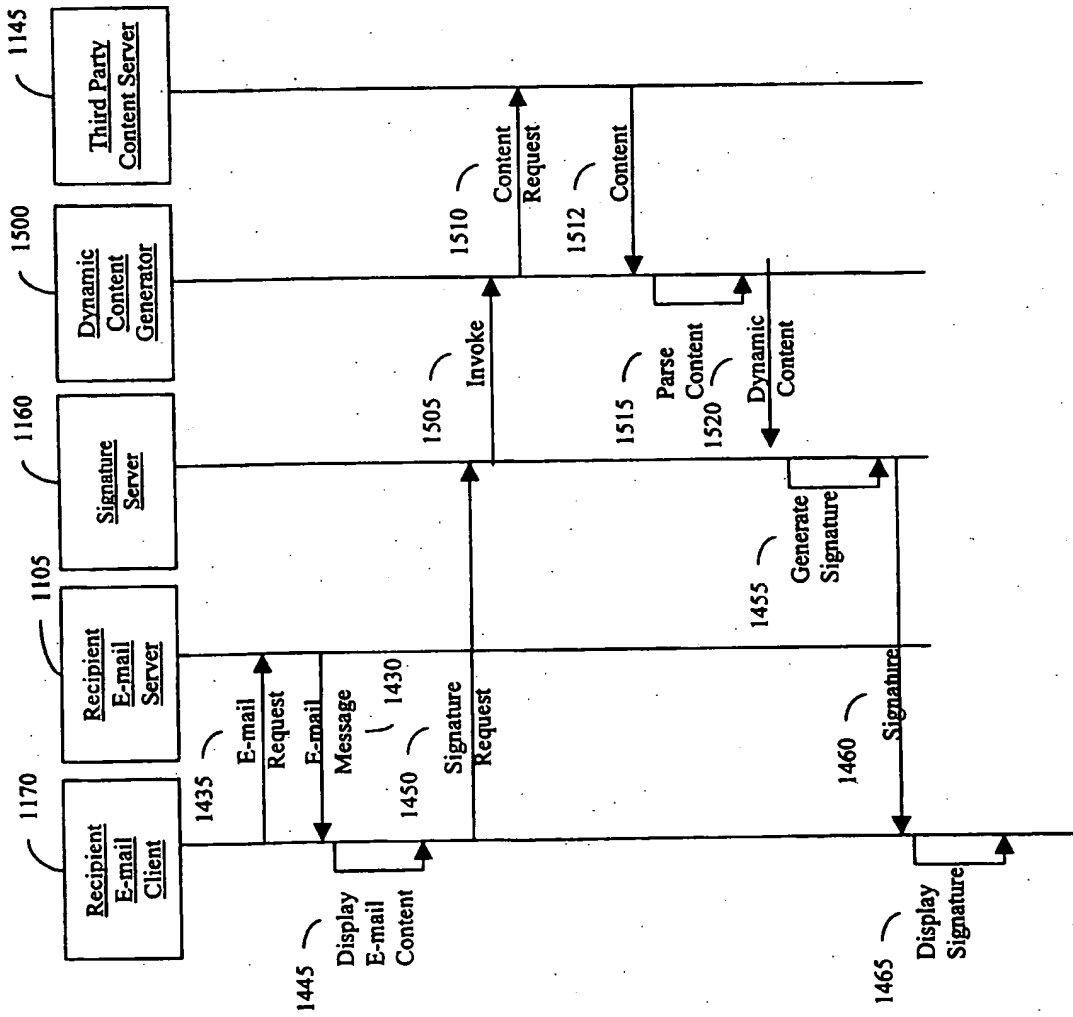

FIG. 9

10/30

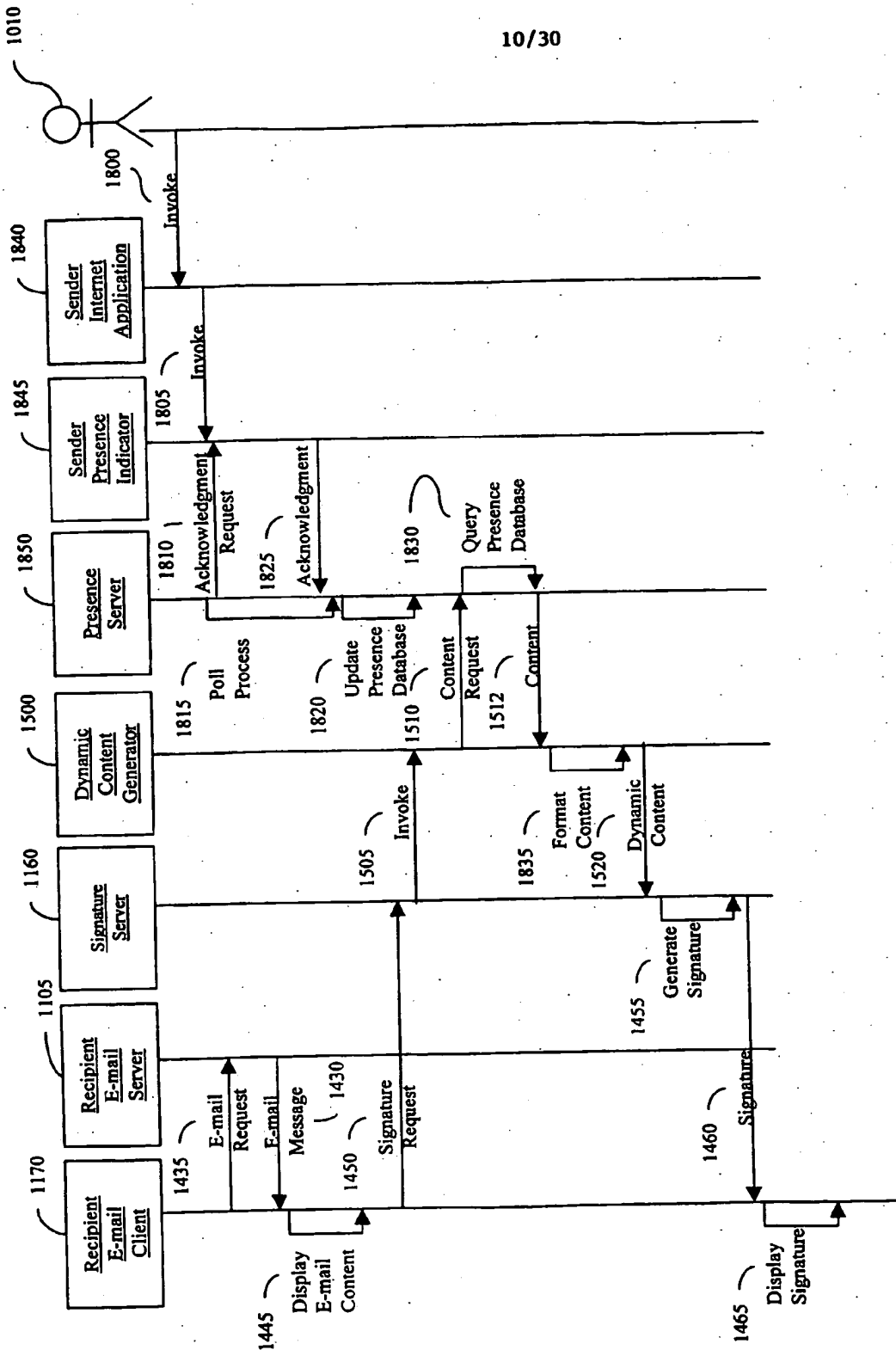

FIG. 10

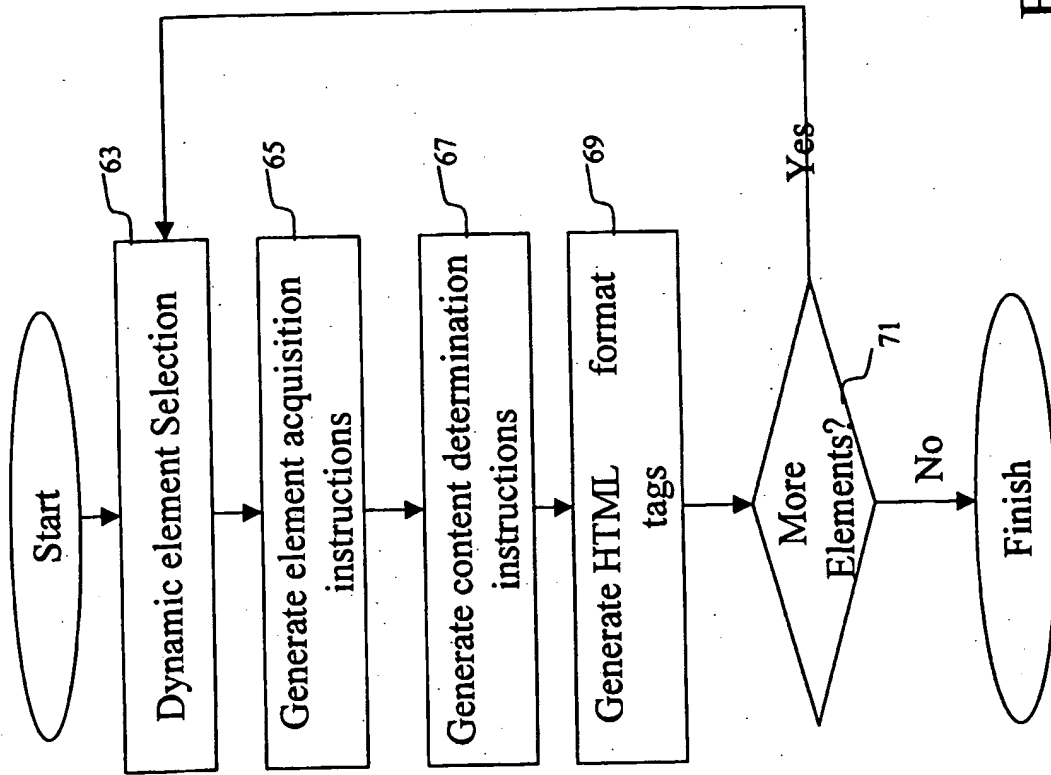

Fig. 11

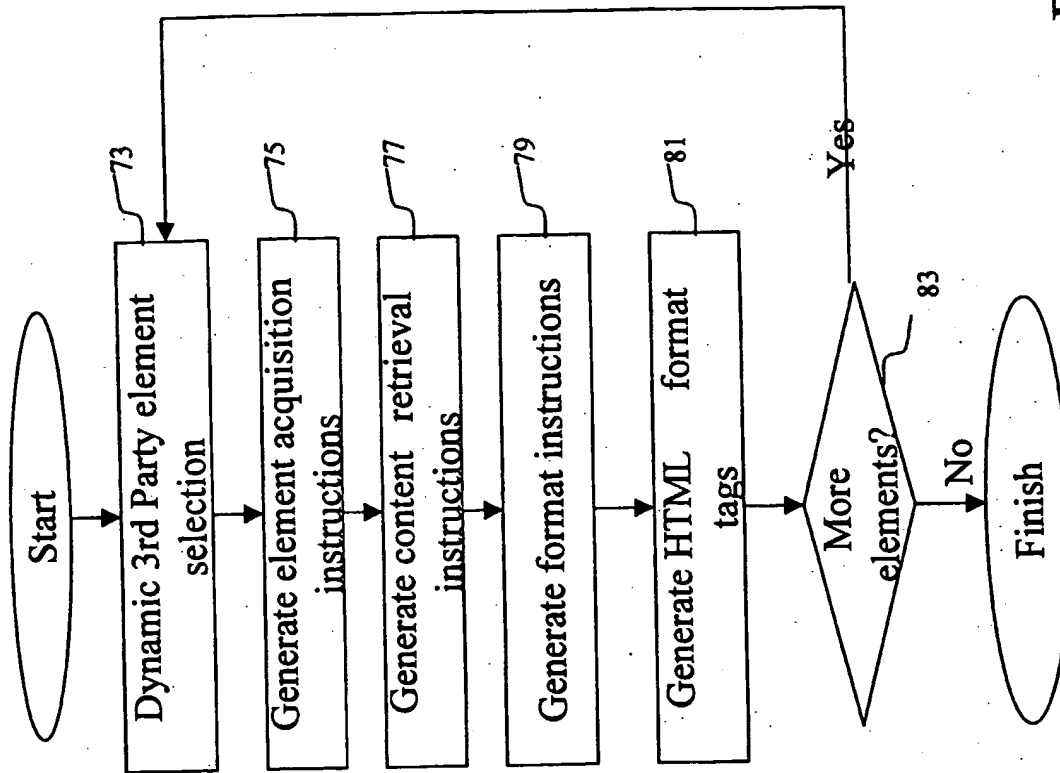

Fig. 12

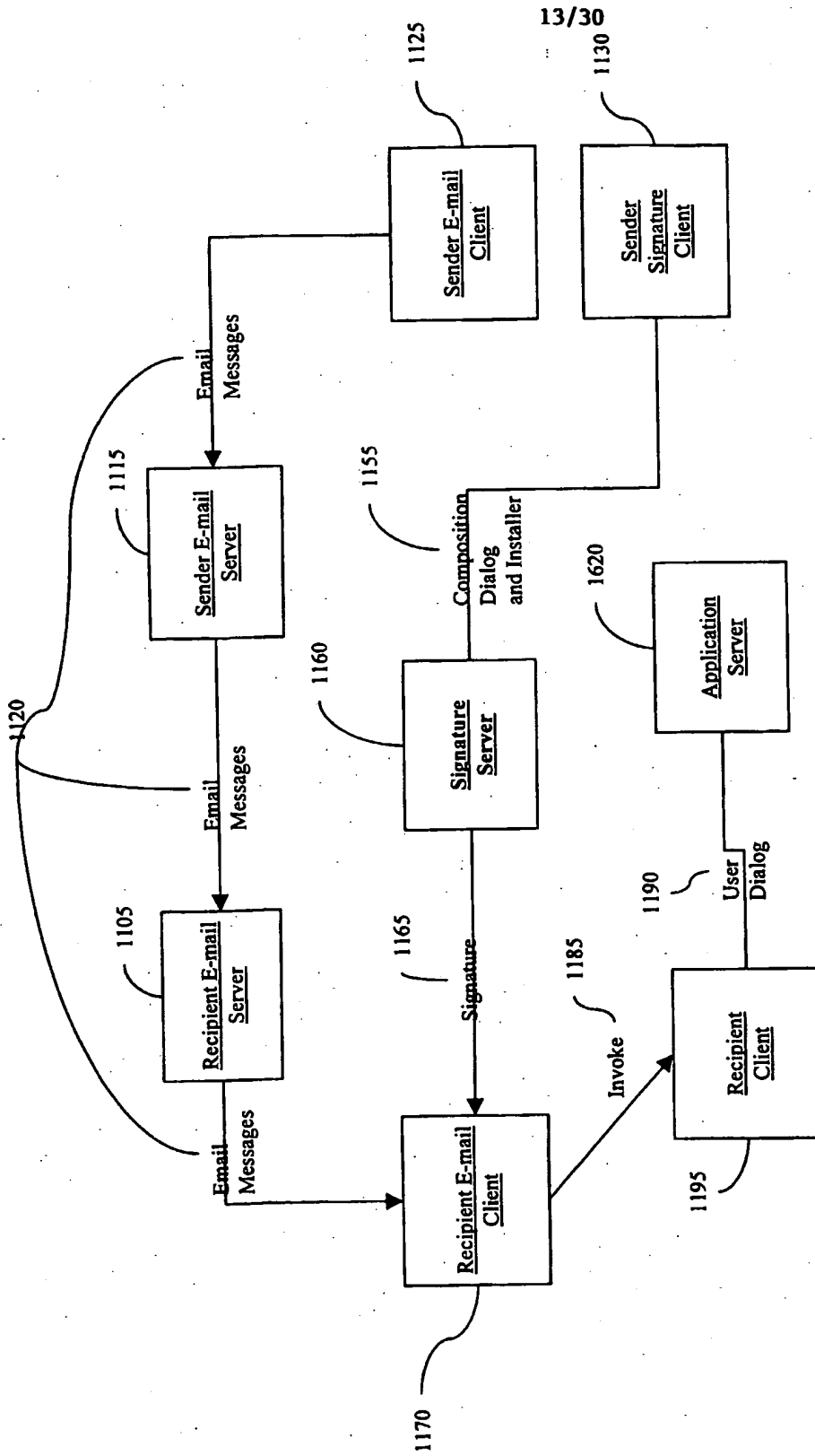

FIG. 13

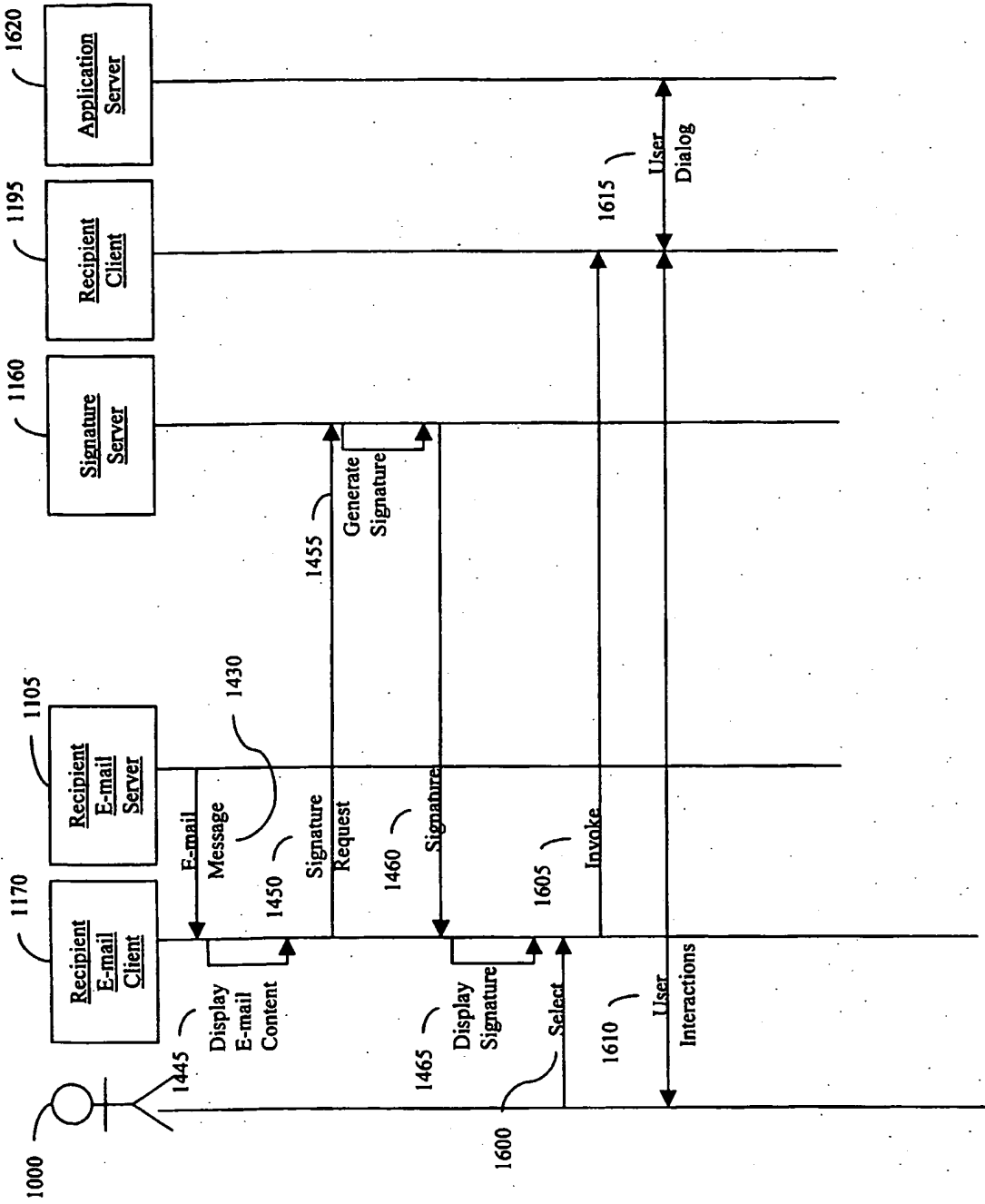

FIG. 14

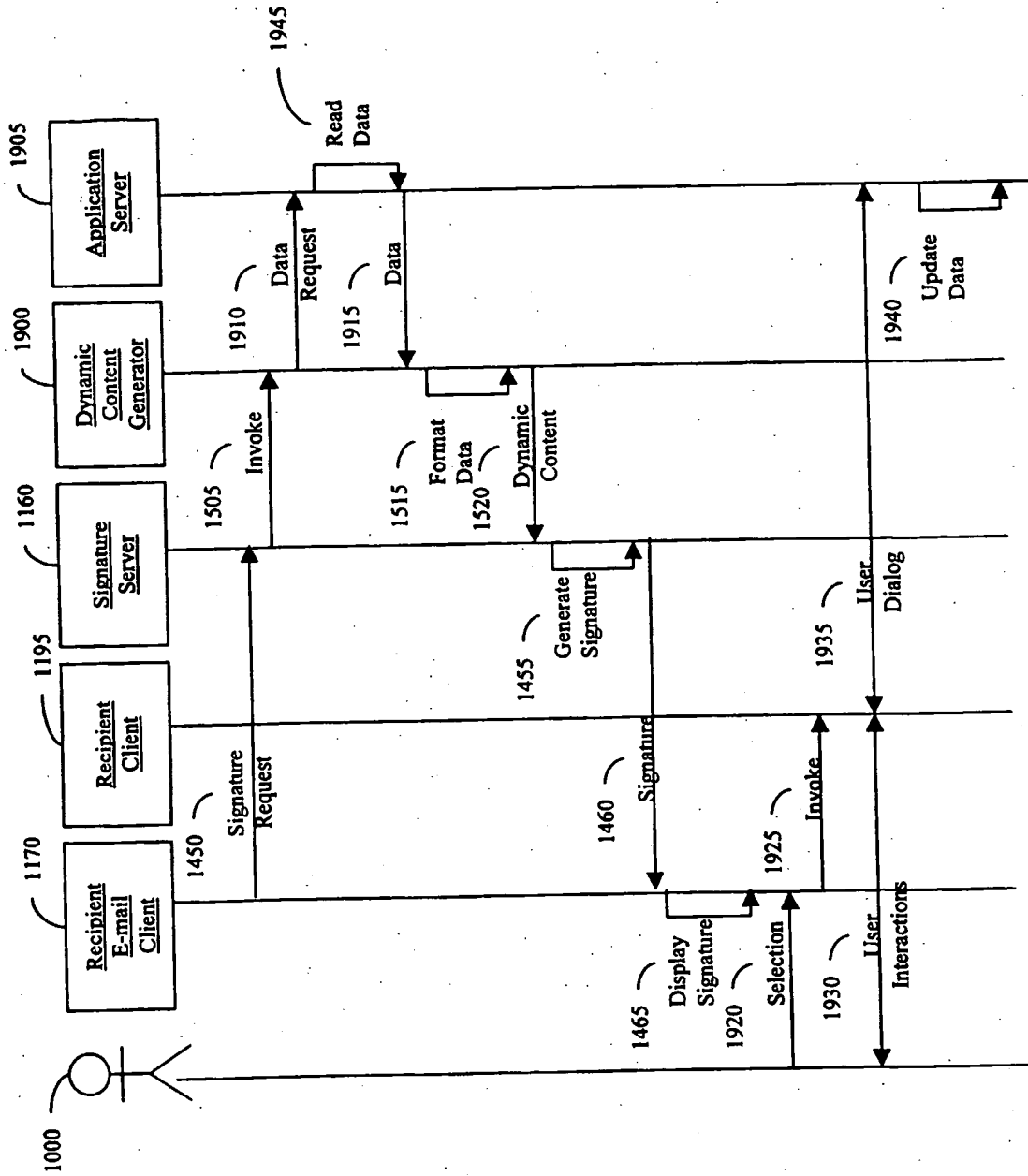

FIG. 15

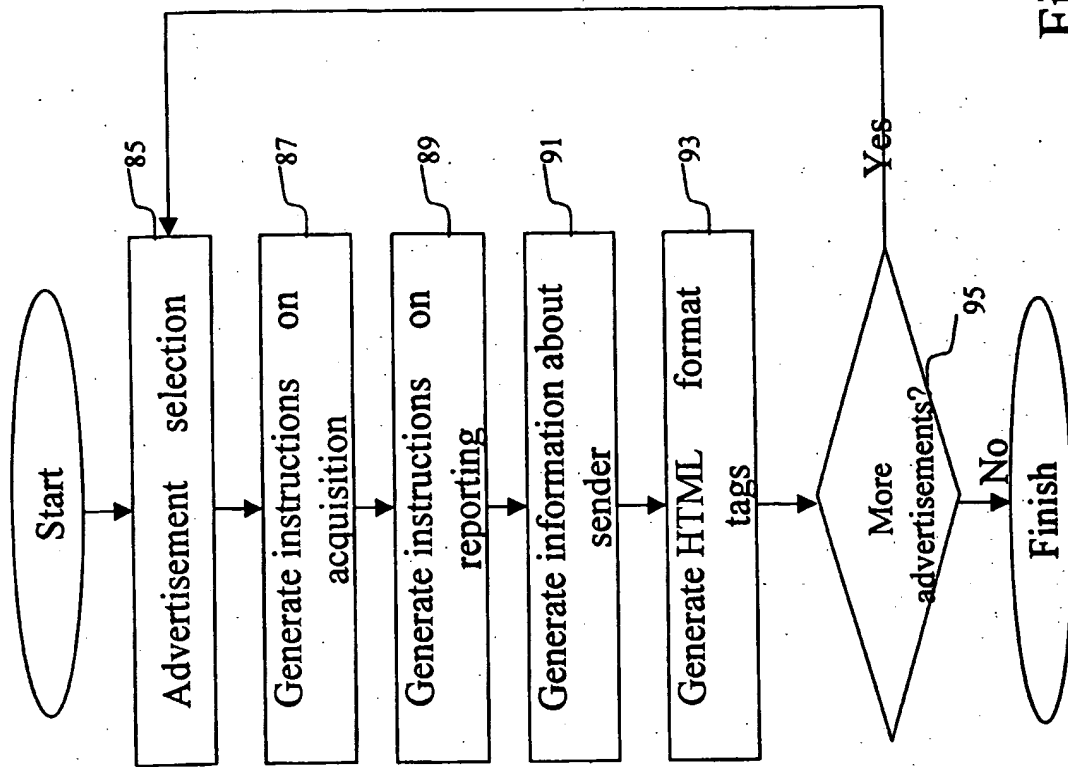

Fig. 16

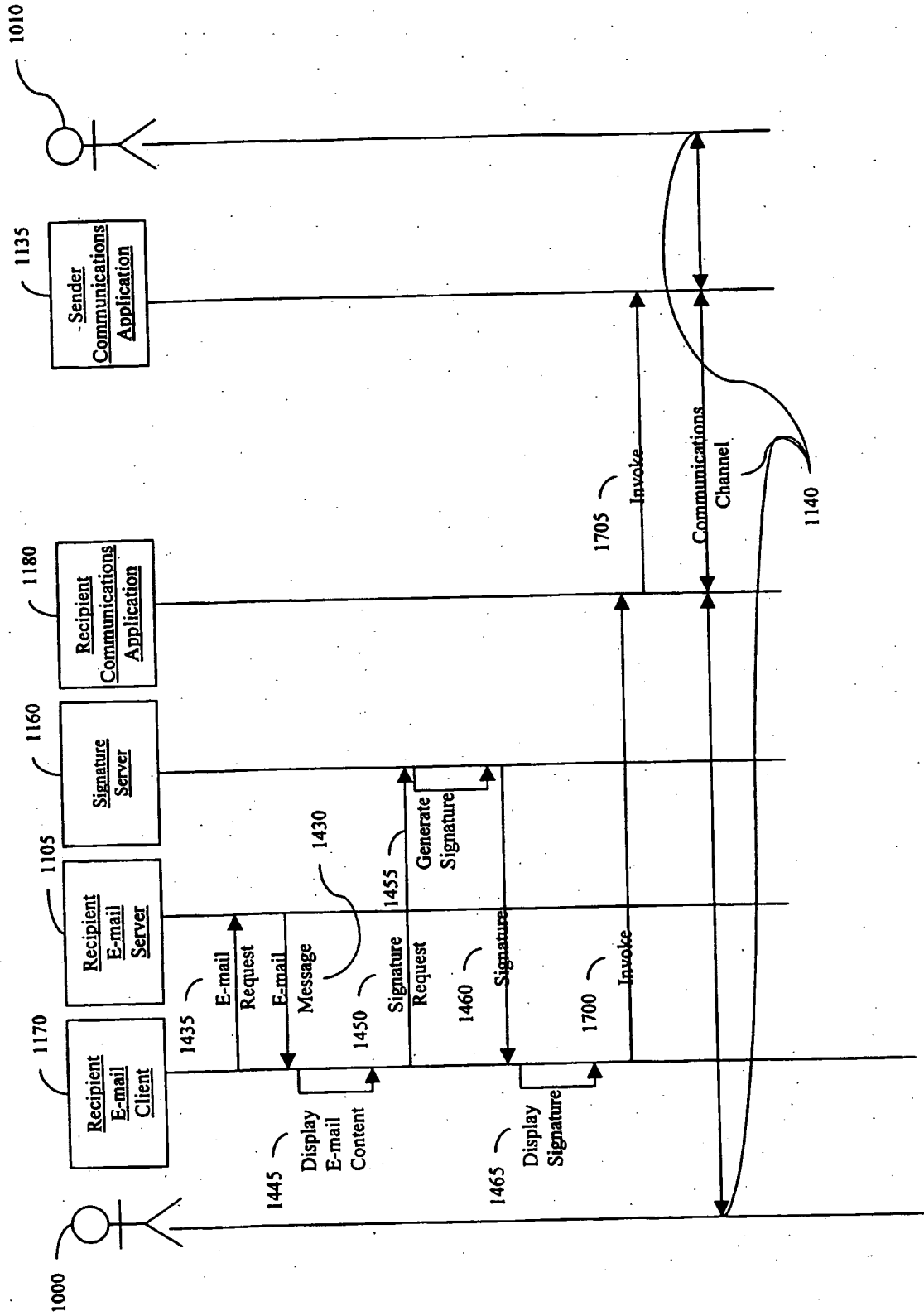

FIG. 17

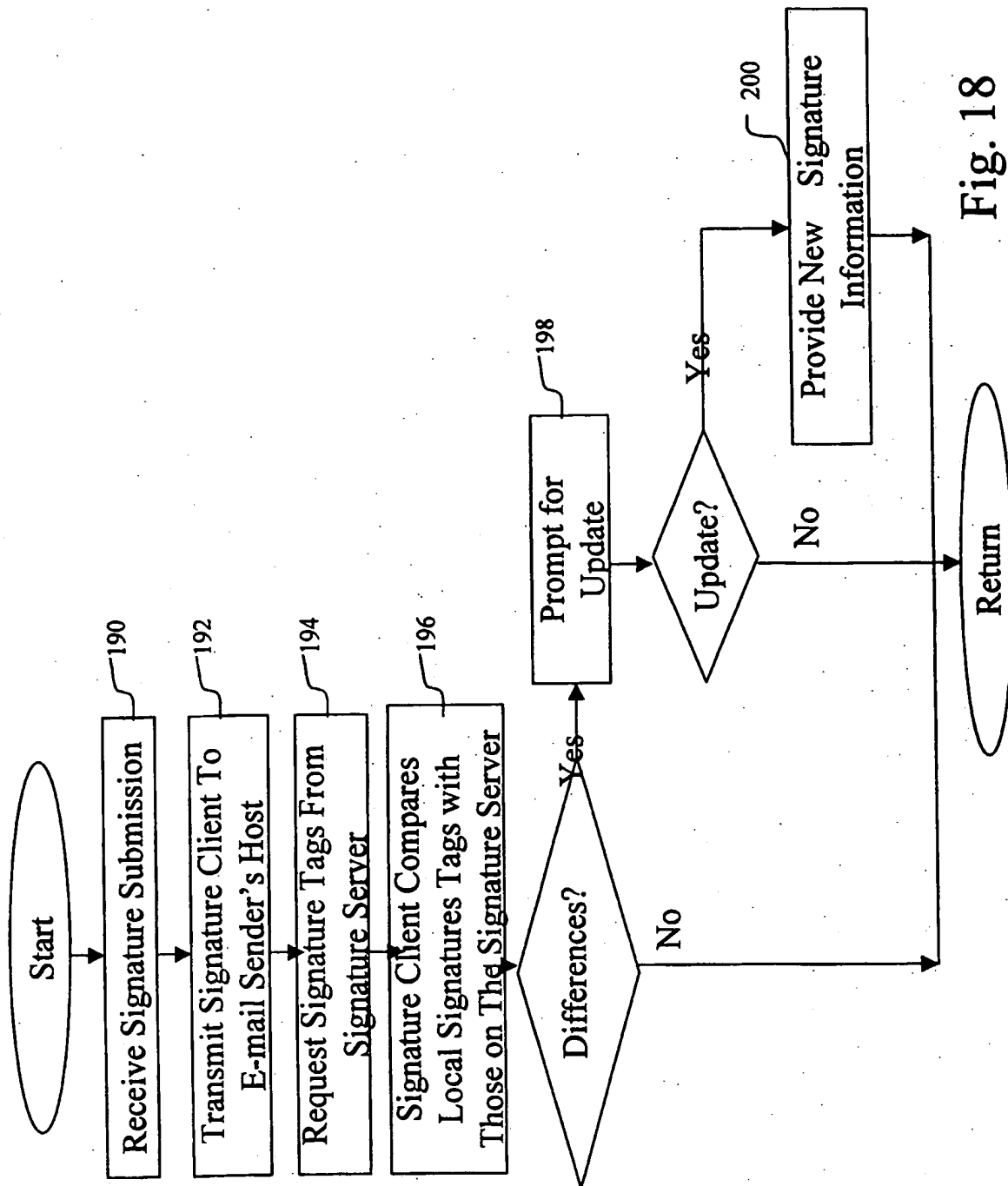

Fig. 18

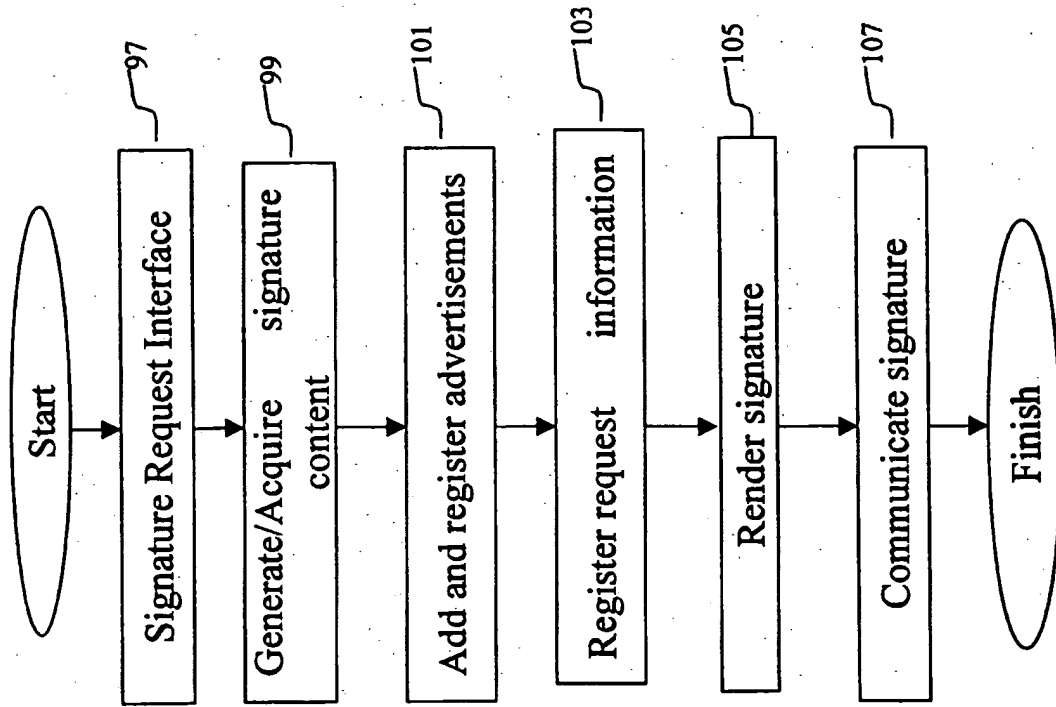

Fig. 19

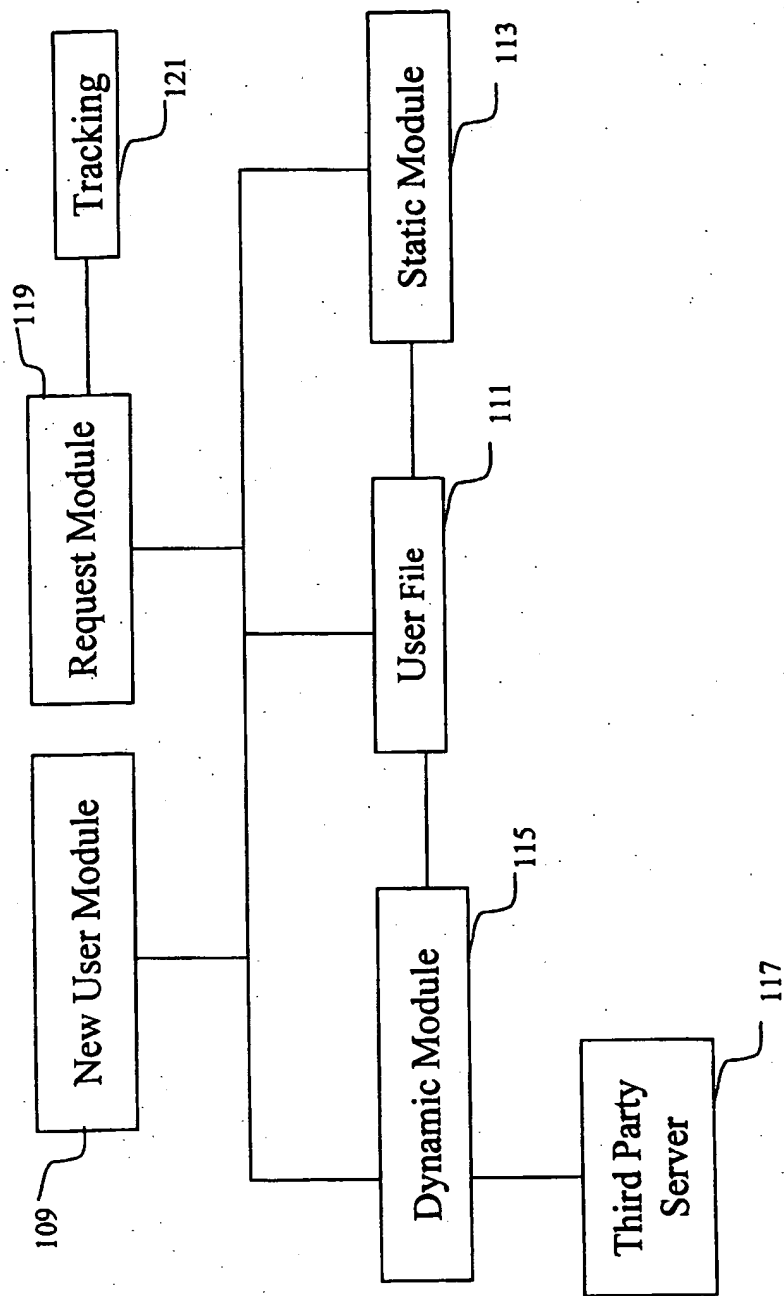

Fig. 20

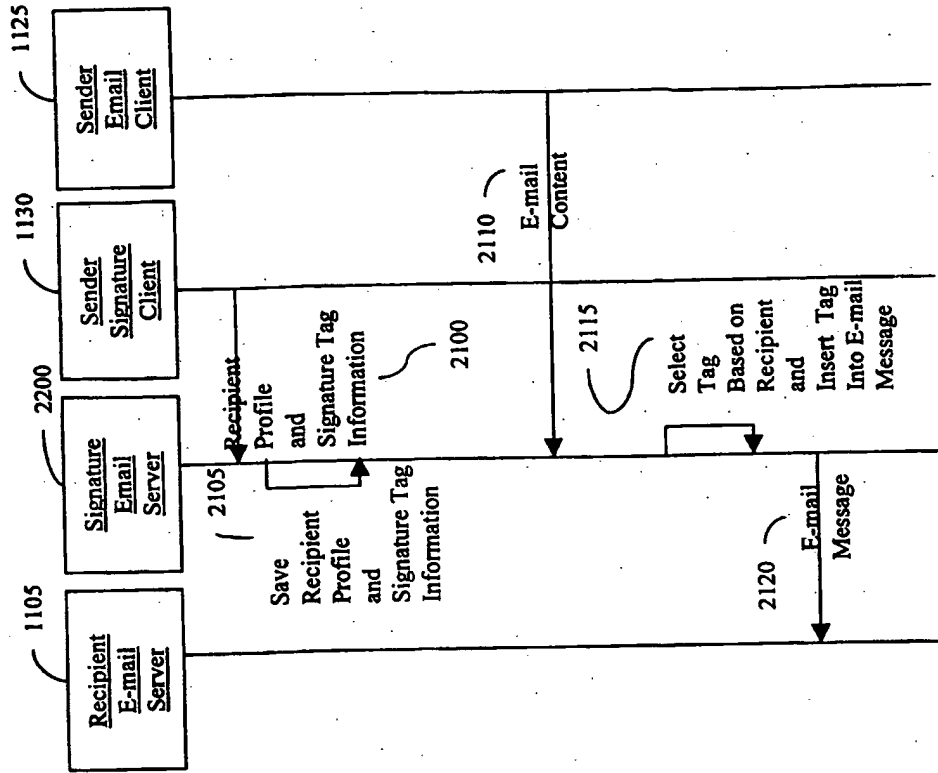

Fig. 22

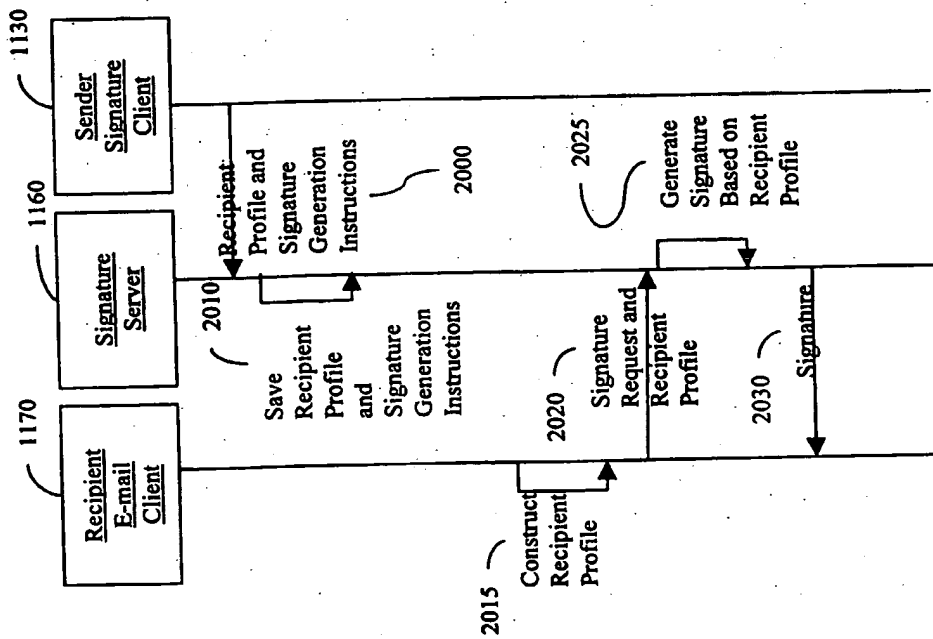

Fig. 21

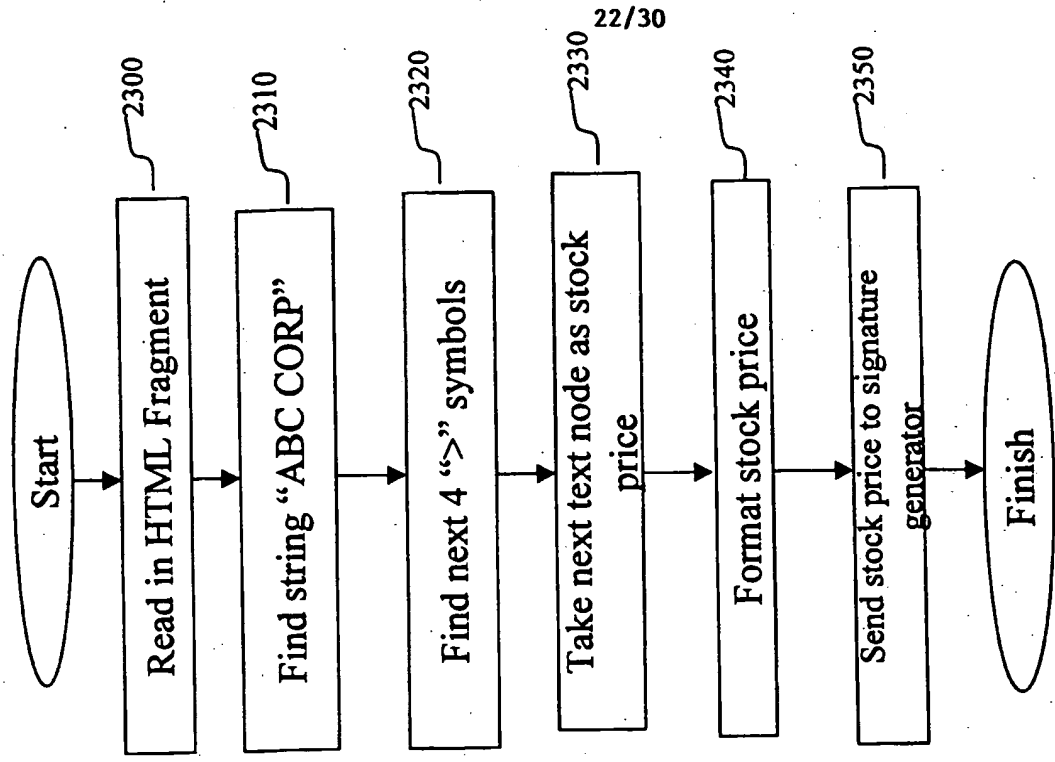

Fig. 24

```

2200 <td nowrap align=left>
      <a href="/q?s=ABC CORP&d=t">
        ABC CORP
      </a>
    </td>
2210 <td nowrap>
      <b>
        66
      </b>
    </td>
      <td nowrap>
        <font color=ff0020>
          -4
        </font>
      </td>
      <td nowrap>
        <font color=ff0020>
          -5.71%
        </font>
      </td>
  
```

Fig. 23

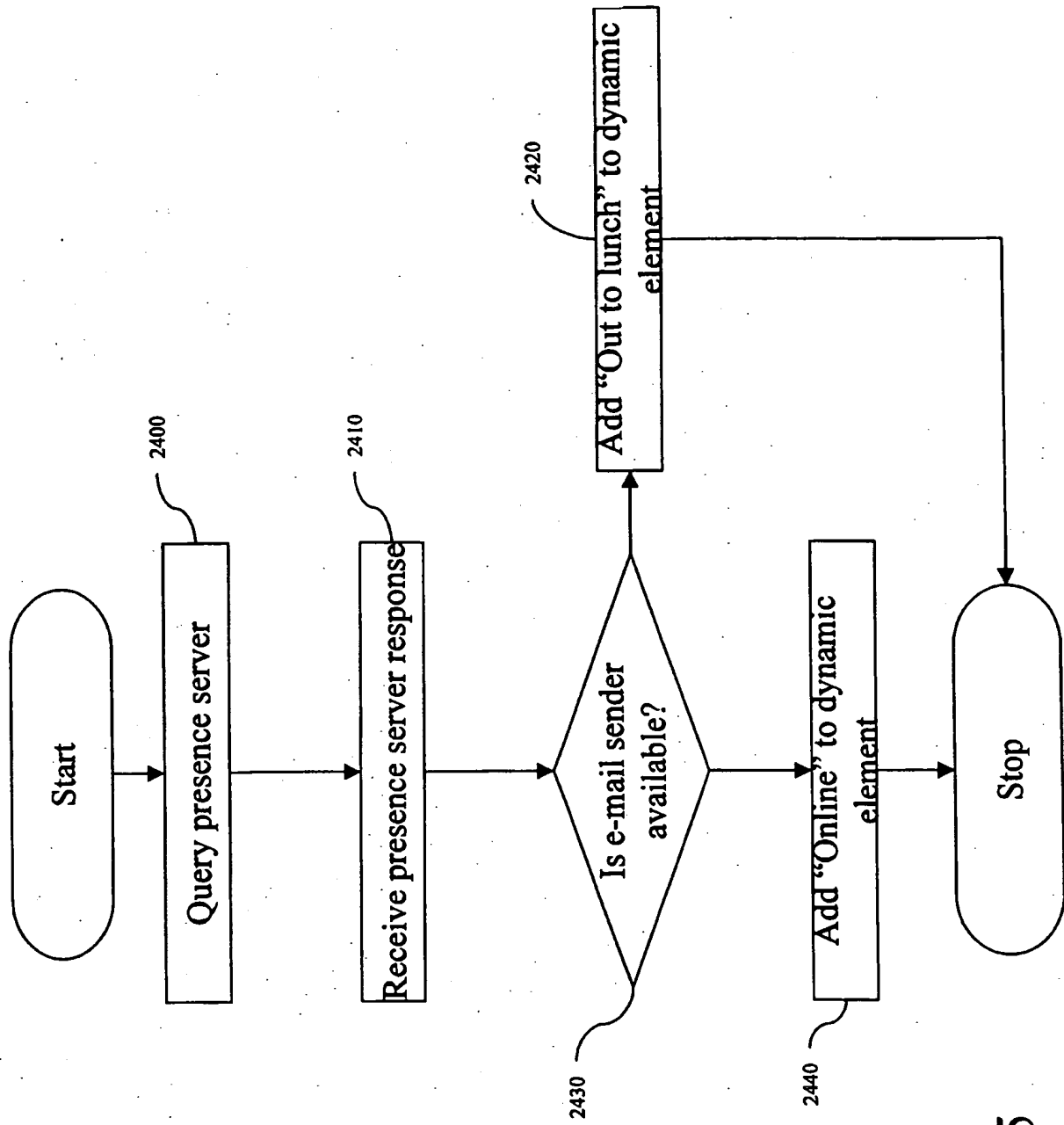

Fig. 25

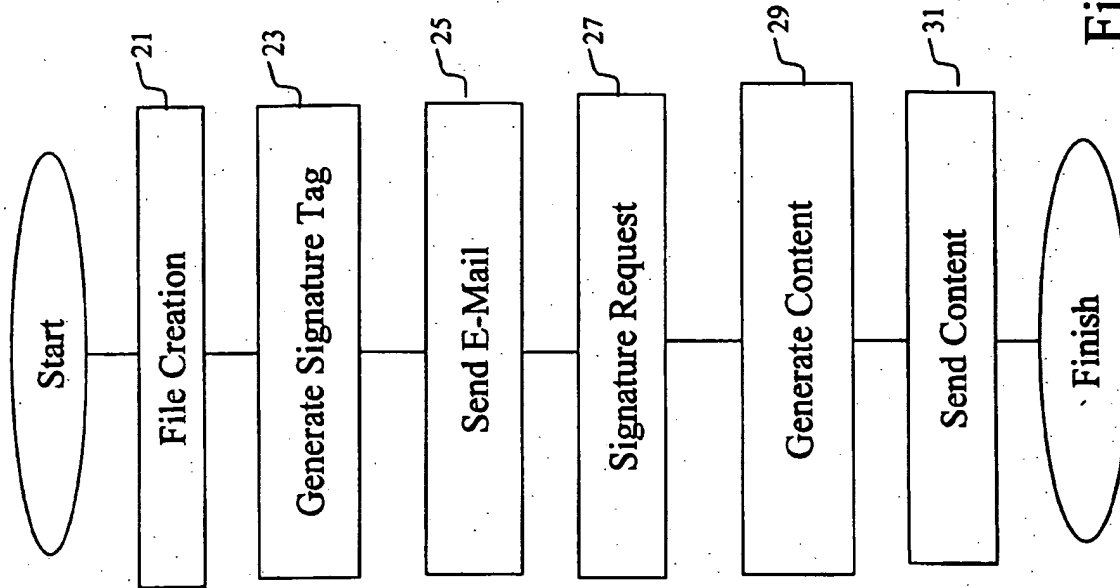

Fig. 26

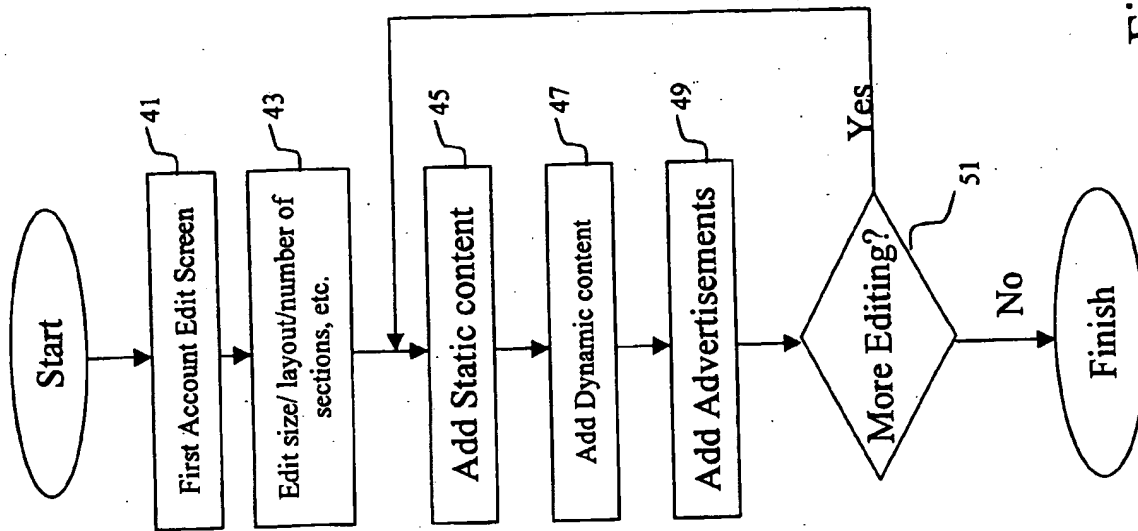

Fig. 27

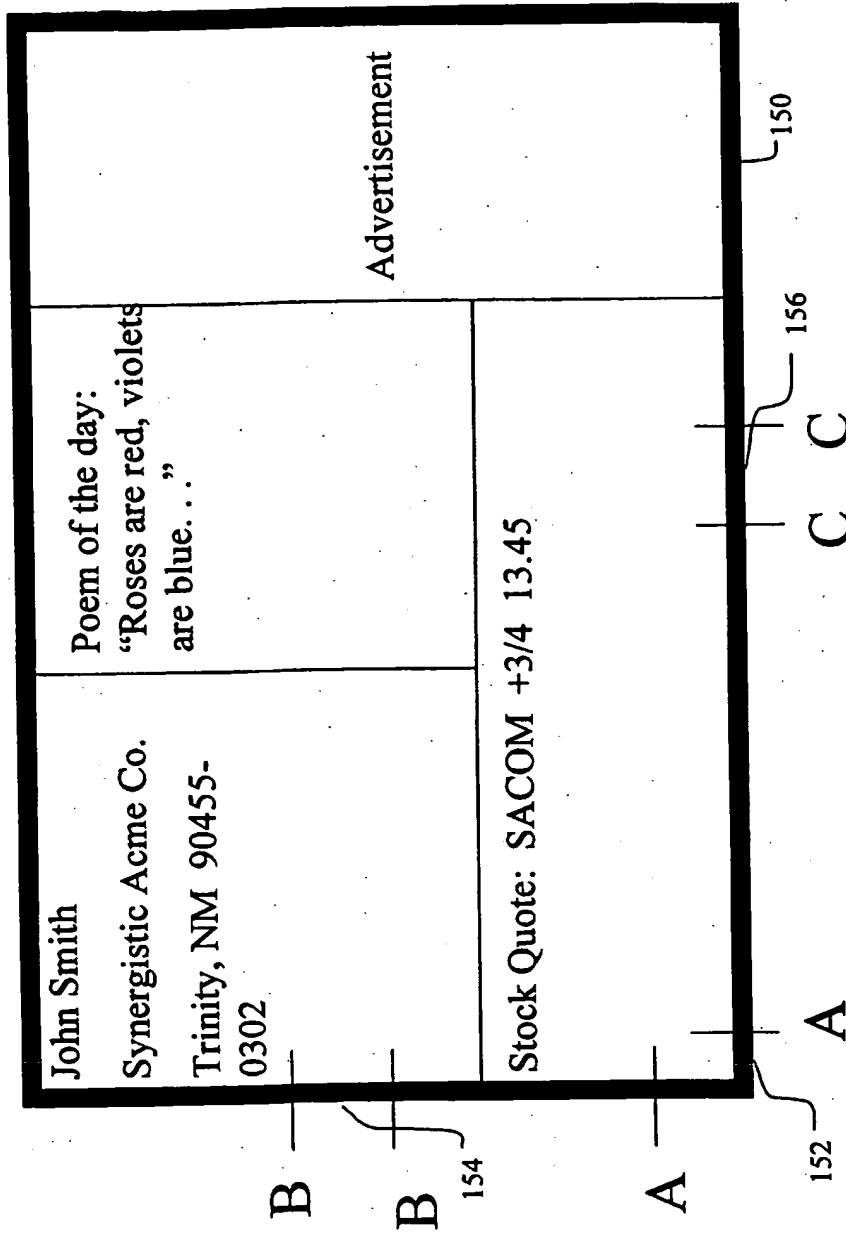

Fig. 28

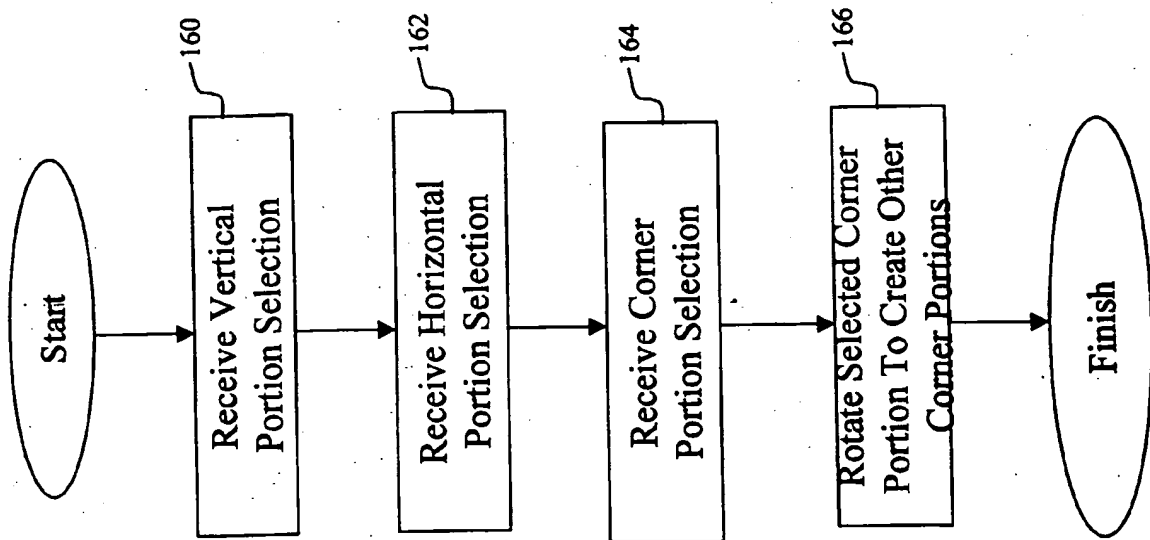

Fig. 29

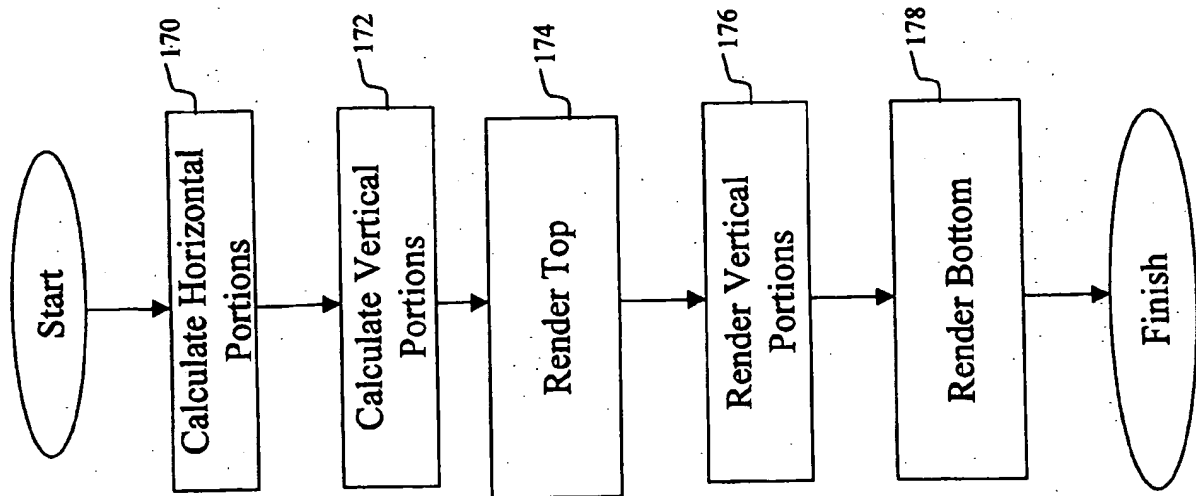

Fig. 30

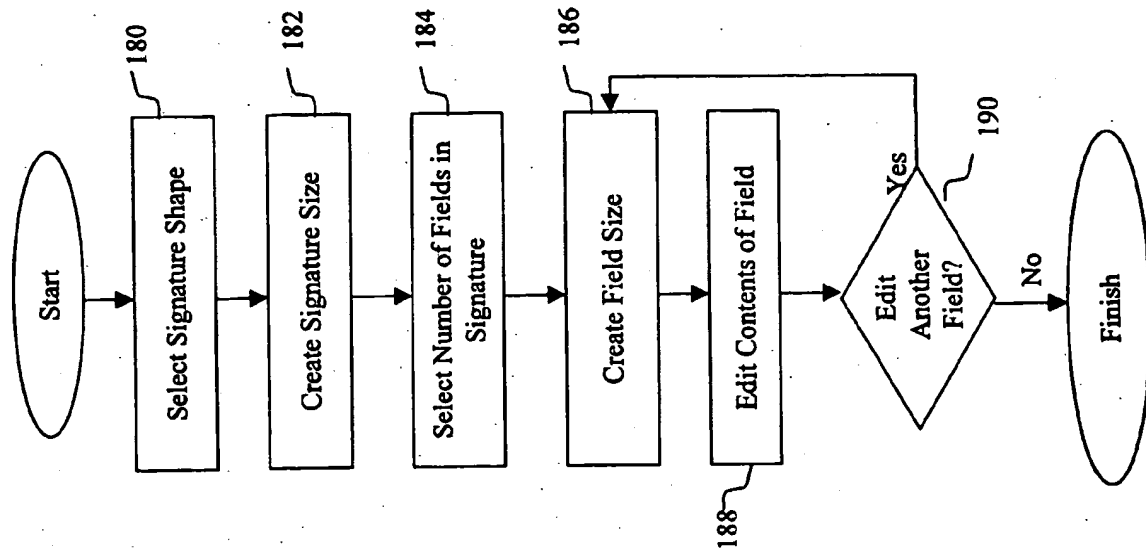

Fig. 31

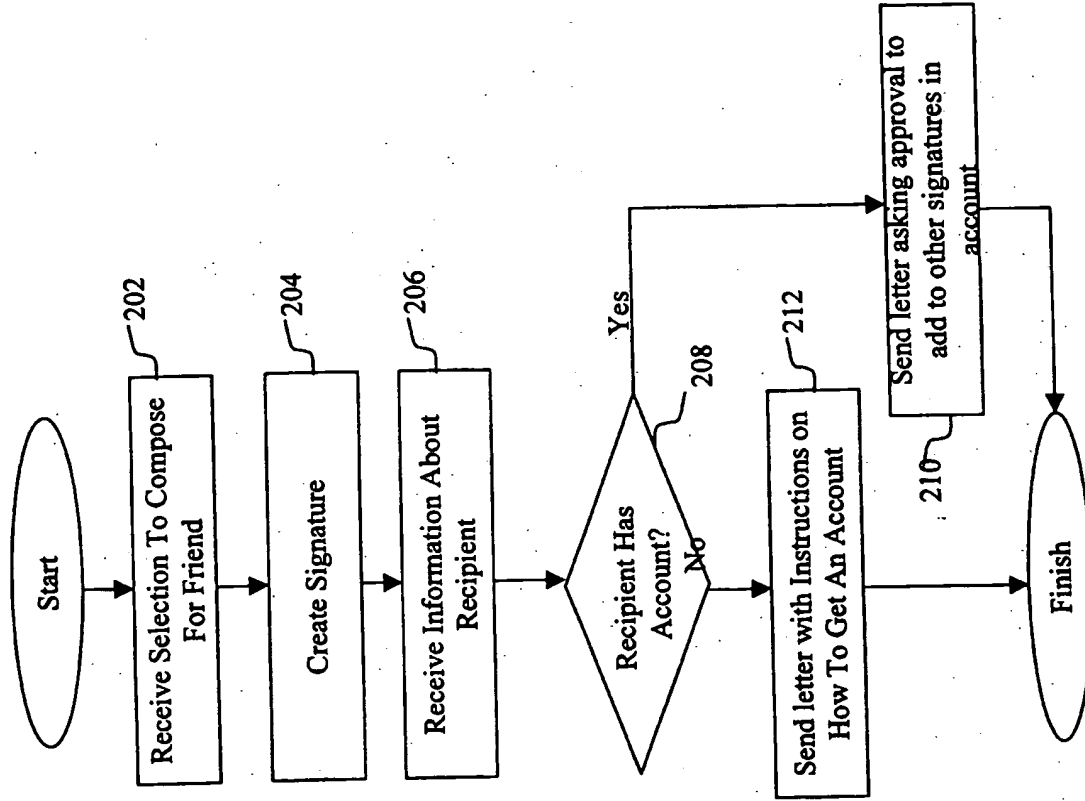

Fig. 32

**This Page is Inserted by IFW Indexing and Scanning
Operations and is not part of the Official Record**

BEST AVAILABLE IMAGES

Defective images within this document are accurate representations of the original documents submitted by the applicant.

Defects in the images include but are not limited to the items checked:

BLACK BORDERS

IMAGE CUT OFF AT TOP, BOTTOM OR SIDES

FADED TEXT OR DRAWING

BLURRED OR ILLEGIBLE TEXT OR DRAWING

SKEWED/SLANTED IMAGES

COLOR OR BLACK AND WHITE PHOTOGRAPHS

GRAY SCALE DOCUMENTS

LINES OR MARKS ON ORIGINAL DOCUMENT

REFERENCE(S) OR EXHIBIT(S) SUBMITTED ARE POOR QUALITY

OTHER: _____

IMAGES ARE BEST AVAILABLE COPY.

As rescanning these documents will not correct the image problems checked, please do not report these problems to the IFW Image Problem Mailbox.